



HMI connection manual

WUXI XINJE ELECTRIC CO., LTD.

Data No. : HC 01 20130123

CATALOG

1 SERIAL PORT OF HMI	1
1.1 Download port	1
1.2 PLC port	3
1.3 Expand port	3
1.4 Ethernet port	5
2 THE CONNECTION OF PLC AND HMI	8
2.1 XINJE FC series PLC	8
2.1.1 Model	8
2.1.2 Parameters	8
2.1.3 Cable making	8
2.1.4 Device address	9
2.2 XINJE XC series PLC	10
2.2.1 Model	10
2.2.2 Parameters	10
2.2.3 Cable making	11
2.2.4 Device address	12
2.3 Mitsubishi FXseries PLC	14
2.3.1 Model	14
2.3.2 Parameters	14
2.3.3 Cable making	15
2.3.4 Device address	16
2.4 Mitsubishi FX3U/G series PLC	17
2.4 .1 Model	17
2.4 .2 Parameters	17
2.4 .3 Cable making	18
2.4 .4 Device address	18
2.5 Mitsubishi FX BD series PLC (RS232/485)	20
2.5.1 Device type	20
2.5.2 Parameters	20
2.5.3 Cable making	21
2.5.3 Device address	22
2.6 Mitsubishi Q series PLC	23
2.6.1 Model	23
2.6.2 Parameters	23
2.6.3 Cable making	26
2.6.4 Device address	27
2.7 Siemens S7-200 series PLC	29
2.7.1 Model	29
2.7.2 Parameters	29
2.7.3 Cable making	29
2.7.4 Device address	30

2.8 Siemens S7-300/400 series PLC.....	31
2.8.1 Model.....	31
2.8.2 Parameters	31
2.8.3 Cable making.....	33
2.8.4 Device address.....	34
2.9 OMRON SYSMAC series PLC	35
2.9.1 Device model.....	35
2.9.2 Parameters	36
2.9.3 Cable making.....	36
2.9.4 Device address.....	38
2.10 Koyo S series PLC.....	39
2.10.1 Device model.....	39
2.10.2 Parameters	40
2.10.3 Cable making.....	41
2.10.4 Device address.....	42
2.11 Koyo DL series PLC.....	43
2.11.1 Device type	43
2.11.2 Parameters	43
2.11.3 Cable making.....	43
2.11.4 Device address	44
2.12 Delta DVP series PLC	45
2.12.1 Model.....	45
2.12.2 Parameters	45
2.12.3 Cable making.....	45
2.12.4 Device address.....	46
2.13 LG Master-K(CPU Direct) series PLC.....	47
2.13.1 Device model.....	47
2.13.2 Parameters	47
2.13.3 Cable making.....	48
2.13.4 Device address.....	48
2.14 LG Master-K(Cnet) series PLC	50
2.14.1 Device model.....	50
2.14.2 Parameters	50
2.14.3 Cable making.....	51
2.14.4 Device address.....	52
2.15 LG Glofa(Cnet) series PLC	53
2.15.1 Device model.....	53
2.15.2 Parameters	53
2.15.3 Cable making.....	55
2.15.4 Device address.....	56
2.16 LG XGT(CPU Direct) series PLC.....	58
2.16.1 Device model.....	58
2.16.2 Parameters	58
2.16.3 Cable making.....	58

2.16.4 Device address.....	59
2.17 Matsushita MEWNET FP series PLC	60
2.17.1 Device model.....	60
2.17.2 Parameters	60
2.17.3 Cable making.....	61
2.17.4 Device address.....	63
2.18 Schneider PLC.....	64
2.18.1 Device model.....	64
2.18.2 Parameters	64
2.18.3 Cable making.....	66
2.18.4 Device address.....	66
2.19 Fatek FB series PLC	67
2.19.1 Device model.....	67
2.19.2 Parameters	67
2.19.3 Cable making.....	67
2.19.4 Device address.....	69
2.20 Vigor VIGOR PLC	70
2.20.1 Device model.....	70
2.20.2 Parameters	70
2.20.3 Cable making.....	70
2.20.4 Device address.....	72
2.21 Fuji SPB series PLC	73
2.21.1 Device model.....	73
2.21.2 Parameters	73
2.21.3 Cable making.....	73
2.21.4 Device address.....	74
2.22 Keyence KV series PLC	76
2.22.1 Device model.....	76
2.22.2 Parameters	76
2.22.3 Cable making.....	76
2.22.4 Device address.....	78
2.23 Emerson EC20 series PLC	79
2.23.1 Device model.....	79
2.23.2 Parameters	79
2.23.3 Cable making.....	79
2.23.4 Device address.....	80
2.24 OEMax NX7 series PLC	81
2.24.1 Device model.....	81
2.24.2 Device address.....	81
2.24.3 Cable making.....	81
2.24.4 Device address.....	83
2.25 Bosch Rexroth IndraControl L40 series PLC.....	84
2.25.1 Device model.....	84
2.25.2 Parameters	84

2.25.3 Cable making.....	84
2.25.4 Device address.....	85
2.26 OPTO 22 SNAP series PLC	86
2.26.1 Device model.....	86
2.26.2 Parameters	86
2.26.3 Cable making.....	86
2.26.4 Device address.....	87
2.27 SAIA-Burgess PCD series PLC	88
2.27.1 Device model.....	88
2.27.2 Parameters	89
2.27.3 Cable making.....	89
2.27.4 Device address.....	93
2.28 Allen-Bradley series PLC	93
2.28.1 Device model.....	93
2.28.2 Parameters	93
2.28.3 Cable making.....	96
2.28.4 Device address.....	96
2.29 Xinje V5 series inverter	98
2.29.1 Device model.....	98
2.29.2 Parameters	98
2.29.3 Cable making.....	99
2.30 SHIMADEN.....	100
2.30.1 Device model.....	100
2.30.2 Parameters	100
2.30.3 Cable making.....	100
2.30.4 Device address.....	101
2.31 Modbus RTU (panel is Master)	102
2.31.1 Device model.....	102
2.31.2 Parameters	102
2.31.3 Cable making.....	102
2.31.4 Device address.....	103
2.32 Modbus ASCII (Panel is Master).....	104
2.32.1 Device model.....	104
2.32.2 Parameters	104
2.32.3 Cable making.....	104
2.32.4 Device address.....	105
2.33 Modbus slave (panel is Slave)	106
2.33.1 Device model.....	106
2.33.2 Parameters	106
2.33.3 Cable making.....	106
2.33.4 Device address.....	107
2.34 ABB PLC.....	108
2.34.1 Device model.....	108
2.34.2 Parameters	108

2.34.3 Cable making.....	109
2.34.4 Device address.....	110
2.35 IDEC.....	111
2.35.1 Device type.....	111
2.35.2 Parameters.....	111
2.35.3 Cable making.....	111
2.35.4 Device address.....	112
2.36 TAIAN.....	113
2.36.1 Device type.....	113
2.36.2 Parameters.....	114
2.36.3 Cable making.....	114
2.36.4 Device address.....	115
2.37 YuDian AI.....	116
2.37.1 Device address.....	116
2.37.2 Parameters.....	116
2.37.3 Cable making.....	116
2.37.4 Device address.....	117
2.38 Inovance PLC.....	118
2.38.1 Device type.....	118
2.38.2 Parameter.....	118
2.38.3 Cable making.....	119
2.38.4 Device address.....	119
2.39 HaiWell PLC.....	121
2.39.1 Device type.....	121
2.39.2 Parameters.....	121
2.39.3 Cable making.....	121
2.39.4 Device address.....	122
2.40 Hollias PLC.....	123
2.40.1 Device type.....	123
2.40.2 Parameters.....	123
2.40.3 Cable making.....	123
2.40.4 Device address.....	124
2.41 Delta (temperature controller).....	125
2.41.1 Device type.....	125
2.41.2 Parameters.....	125
2.41.3 Cable making.....	125
2.41.4 Device address.....	126
2.42 Siemens S7-1200.....	127
2.42.1 Device type.....	127
2.42.2 Parameters.....	127
2.42.3 Cable making.....	132
2.42.4 Device address.....	133
2.43 Mitsubishi FR series inverter.....	134
2.43.1 Device type.....	134

2.43.2 Parameters	134
2.43.3 Cable making	137
2.44 Sanken VM06 inverter.....	138
2.44.1 Device type	138
2.44.2 Parameters	138
2.44.3 Cable making	140
2.44.4 Device address.....	140
2.45 XINJE XD/XE series.....	141
2.45.1 Device type	141
2.45.2 Parameters	141
2.45.3 Cable making	142
2.45.4 Device address.....	143
2.46 LG XGB series PLC.....	145
2.46.1 Device type	145
2.46.2 Parameters	145
2.46.3 Cable making	148
2.46.4 Device address.....	149
2.47 Koyo Click series	150
2.47.1 Device type	150
2.47.2 Parameter setting	150
2.47.3 Cable making	151
2.47.4 Device address.....	151
2.48 Mitsubishi Melsec protocol	152
2.48.1 Device type	152
2.48.2 Parameter settings.....	153
2.48.3 Cable making	156
2.48.4 Device address.....	157
2.49 Free type (panel is slave).....	157
2.49.1 Device type	157
2.49.2 Parameter setting	158
2.49.3 Cable making	160
2.49.4 Device address.....	161
2.50 Modbus-TCP device	161
2.50.1 Device type	161
2.50.2 Parameter setting	161
2.50.3 Cable making	167
2.50.4 Device address.....	168

1 Serial port of HMI

This chapter will introduce the serial port of HMI.

1.1 Download port

The HMI of XINJE TP and TH series are configured PLC port and download port. Next, it will introduce the port and function. The following diagram is the port of TP460-L.

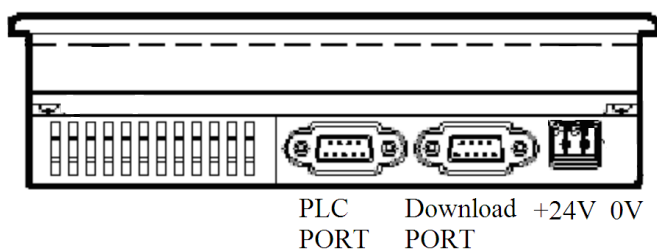

Download port:

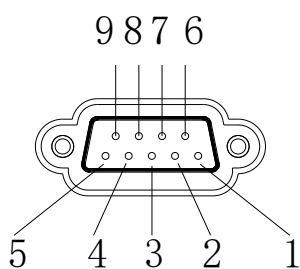

Pin	Name	Explanation
1	NC	Vacant
2	RXD	RS232 receive
3	TXD	RS232 send
4	A	RS485 +
5	GND	Ground
6	NC	Vacant
7	B	RS485 -
8	NC	Vacant
9	NC	Vacant

1. Choose the device to communicate with download port

(a) Build a new project in Touchwin software, choose download port device

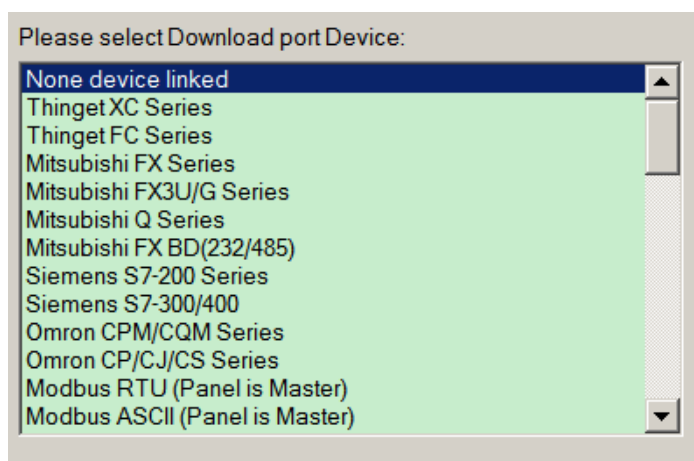

(b) For current project, please set it in the Touchwin software:

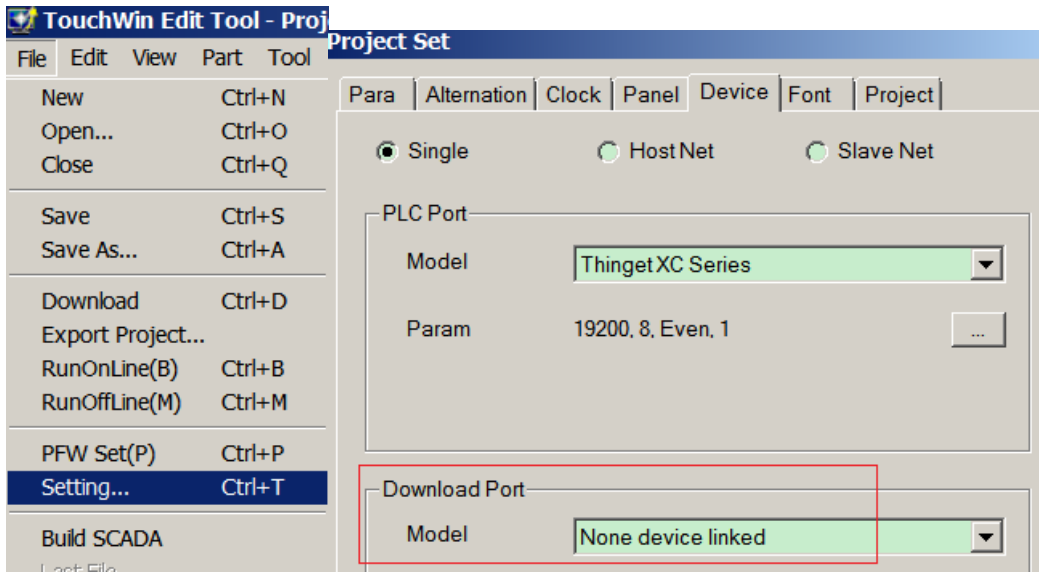

2. Mode switching for download port

The default mode of TH series download port is communication. But it is download mode for TP series. If the download port of TP series needs to switch to communication mode, two pins of the download port must be shorted. Please see the following diagram.

- (1) Cut off the power of TP series HMI, connect pin5 and pin6 of TP download port.
- (2) Power on the HMI, take away the connection cable, the download port will be in communication mode.

pin	name
1	NC
2	FXD
3	TXD
4	A
5	GND
6	BUSY
7	B
8	NC
9	NC

- Note:**
1. if the HMI needs to download program, please restart the HMI.
 2. Please connect the pin 5 and 6 directly.

1.2 PLC port

PLC port:

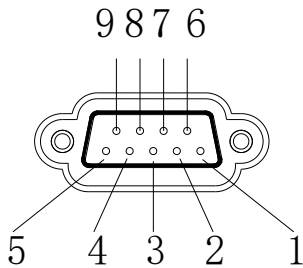

Pin	Name	Explanation
1	TD+	RS422 send -
2	RXD	RS232 receive
3	TXD	RS232 send
4	A	RS485 +
5	GND	Ground
6	TD-	RS422 send -
7	B	RS485 -
8	RDD-	RS422 receive -
9	RDD+	RS422 receive +

For real application, please refer to chapter 2 for cable making. Refer to chapter 1.1 for download port settings.

1.3 Expand port

Expand port:

Pin	Definition	Explanation
1	A	RS485 +
2		
3		
4		
5		
6	B	RS485 -
7		
8		
9		

Note: only TH765-NT3/NU3 has this expand port.

1. choose expand port device

(1) Build a new project, click expand port, and choose the device

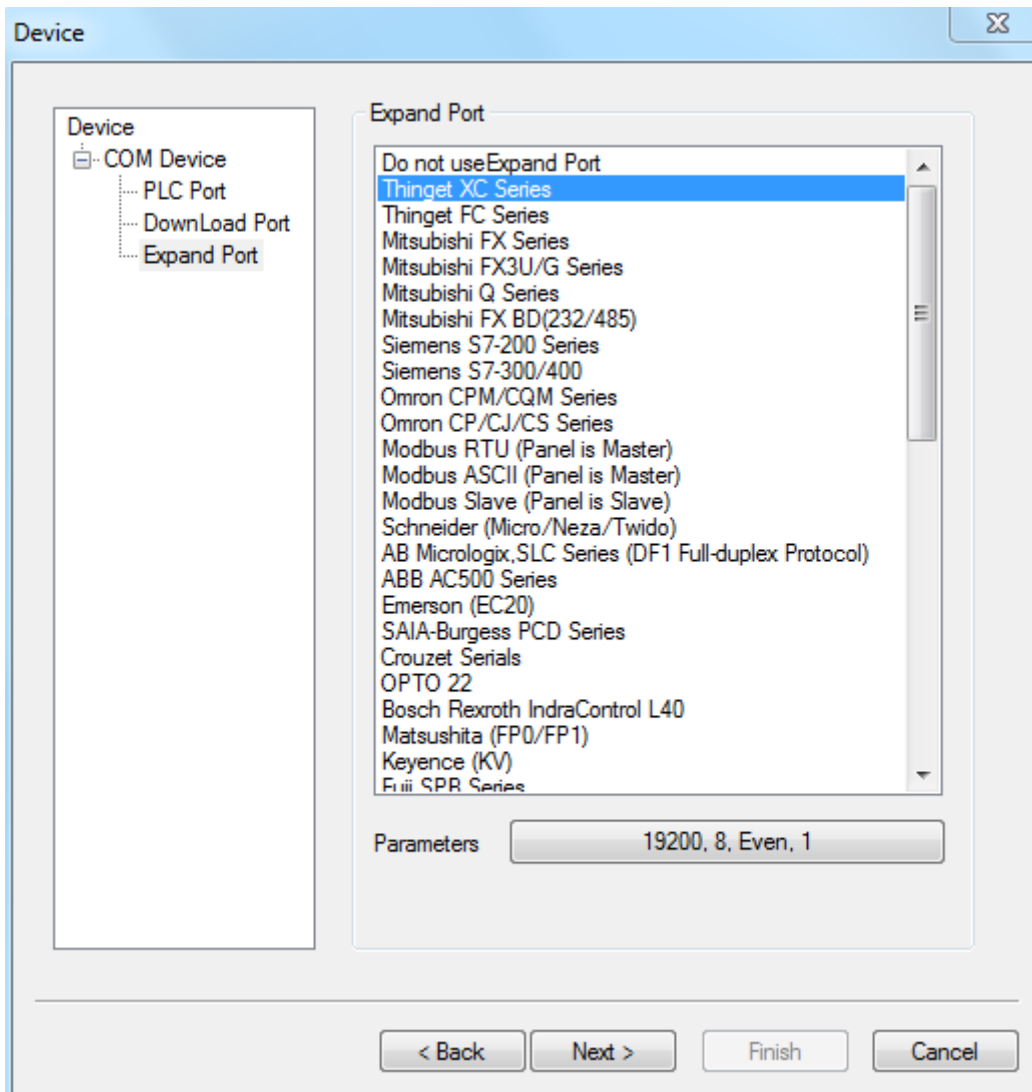

(2) For existed project, click File/setting/device/expand port to set the PLC model.

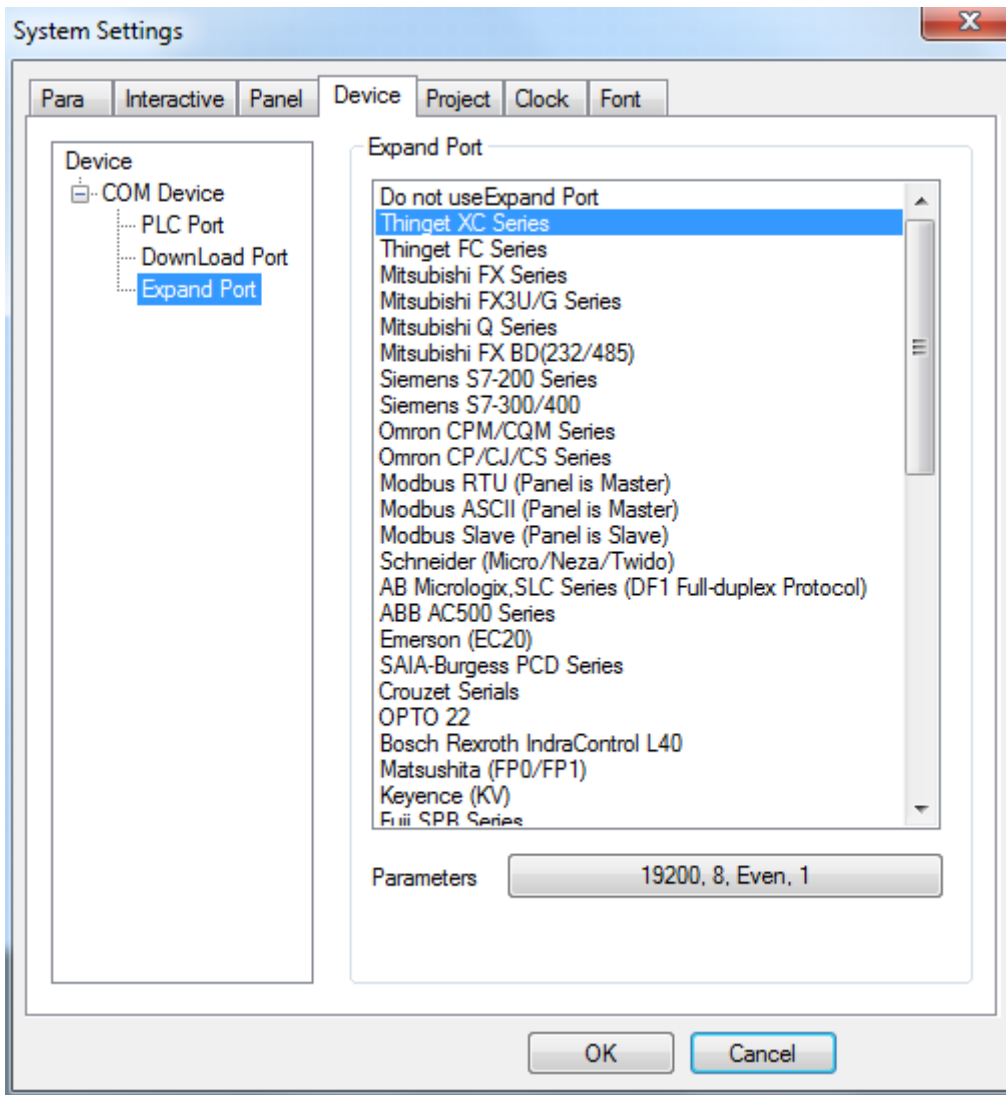

1.4 Ethernet port

RJ45 Ethernet port:

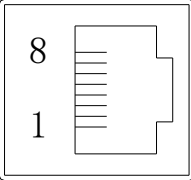
	Pin	Color	Definitio n	Explanation
	1	Orange white	TXD+	Data send +
	2	Orange	TXD-	Data send -
	3	Green white	RXD+	Data receive +
	4	Blue	-	-
	5	Blue white	-	-
	6	Green	RXD-	Data receive -
	7	Brown	-	-

		white		
	8	Brown	-	-

Note: only TG765-ET/TG865-ET/TGA62-ET/TGC65-ET has Ethernet port.

1. Build a new project, choose TG model in the list.

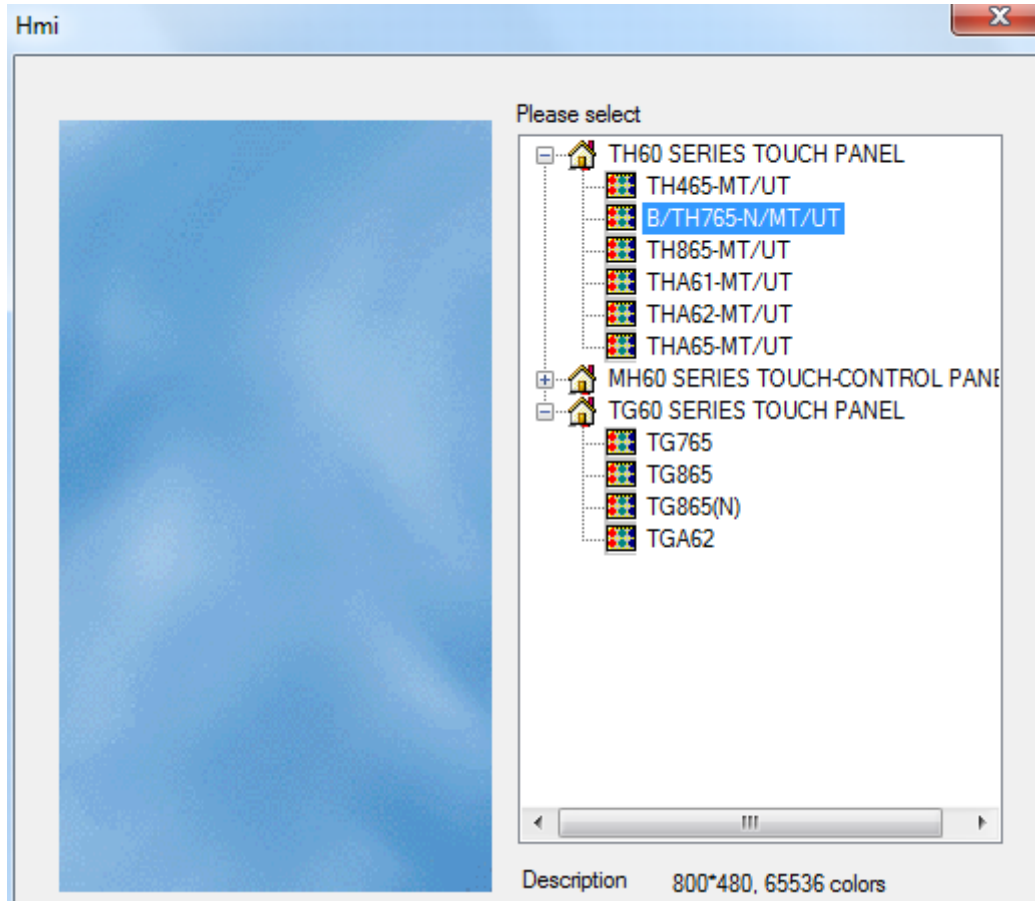

2. Click next, choose net device. Set the IP address of TG series HMI.

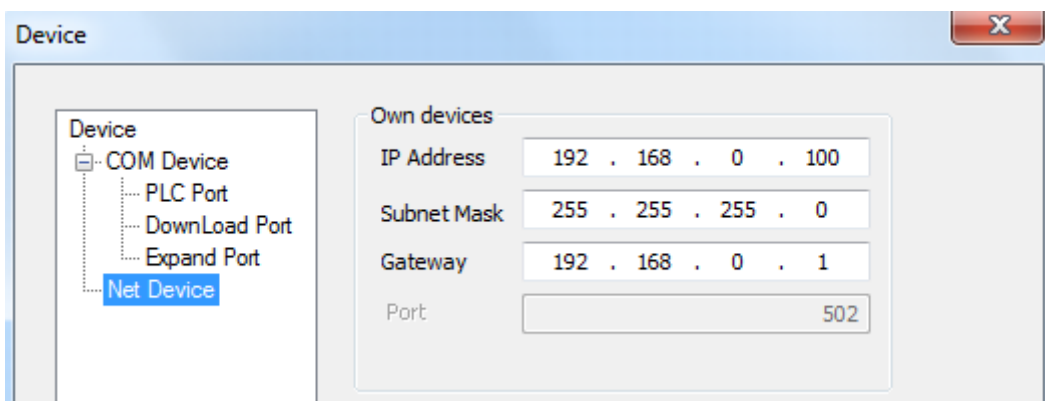

3. Right click net device, build a new Ethernet device.

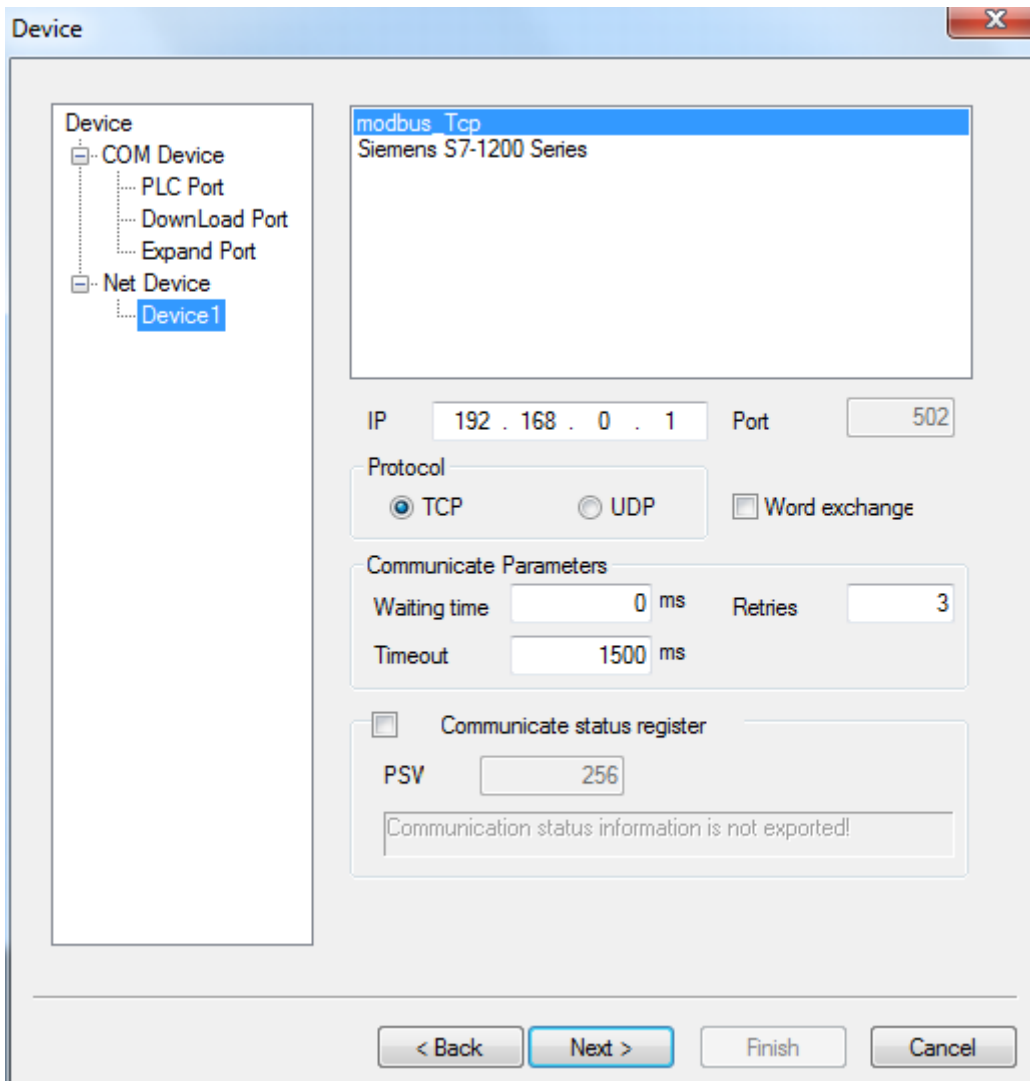

Note: this function support local area network, but not support wide area network

2 The connection of PLC and HMI

This chapter will introduce the connection between PLC and HMI.

Please don't pull out or plug the cable when power on, the serial port may be damaged.

2.1 XINJE FC series PLC

2.1.1 Model

Series	CPU	Connected module	Port	Cable making	Device
FC	XC32V2-CPU030427-R5	CPU direct connection	RS232	Fig1	Xinje FC series
			RS485	Fig2	

2.1.2 Parameters

HMI parameters:

Parameters	Settings	Choices for settings	Item
PLC type	FC series		
Port	RS232	RS232or RS485	
Data bit	8	7 or 8	
Stop bit	1	1 or 2	
Parity	Odd parity	Odd/even/no parity	
Baud rate	9600	4800/38400/9600/115200/19200/187500	
Station No.	0	0~255	

The default communication parameters of FC: 9600, 8, 1, odd parity, station No.0.

2.1.3 Cable making

(a) Connect to FC series CPU (RS232 port)

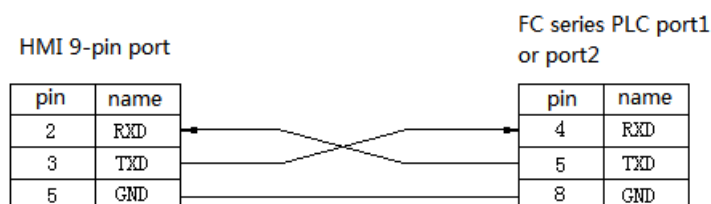

Fig1

(b) Connect to FC series PLC CPU (RS485 port)

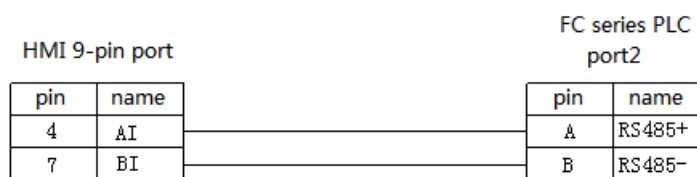

Fig2

2.1.4 Device address

PLC address	Range	Data type	Explanation
X	0~337	Bit	External input coil
Y	0~337	Bit	External output coil
M	0~383	Bit	Internal coil
SM	0~96	Bit	Special coil
T	0~128	Bit	Timer
C	0~128	Bit	Counter
W	0~2047	Word/DWord	Data register
FW	0~191	Word/DWord	FlashROM register
TW	0~127	Word/	Timer register
CW	0~127	Word/	Counter register
SW	0~111	Word//DWord	Special register
WX	0~13	Word//DWord	Input coil register
WY	0~13	Word//DWord	Output coil register
WM	0~23	Word//DWord	Interla coil register

2.2 XINJE XC series PLC

2.2.1 Model

Series	CPU	Connected module	Port	Cable making	Device
XC	XC1\XC2\ XC3\XC5	CPU direct connection	RS232	Fig1	Xinje XC series
			RS485	Fig 2	
		XC-RS485-BD (communication extension board)	RS232	Fig 3	
			RS485	Fig 4	

2.2.2 Parameters

HMI parameters:

Parameter	Recommend settings	Choices of settings	Item
PLC type	XC series	FC/XC series	
Port	RS232	RS232 or RS485	
Data bit	8	7 or 8	
Stop bit	1	1 or 2	
Parity	Even parity	Even/odd/no parity	
Baud rate	19200	4800/38400/9600/115200/19200/187500	
Station No.	1	0~255	

The default communication parameters of XC: 19200, 8, 1, even, station No.1.

PLC settings:

Open XCPpro software:

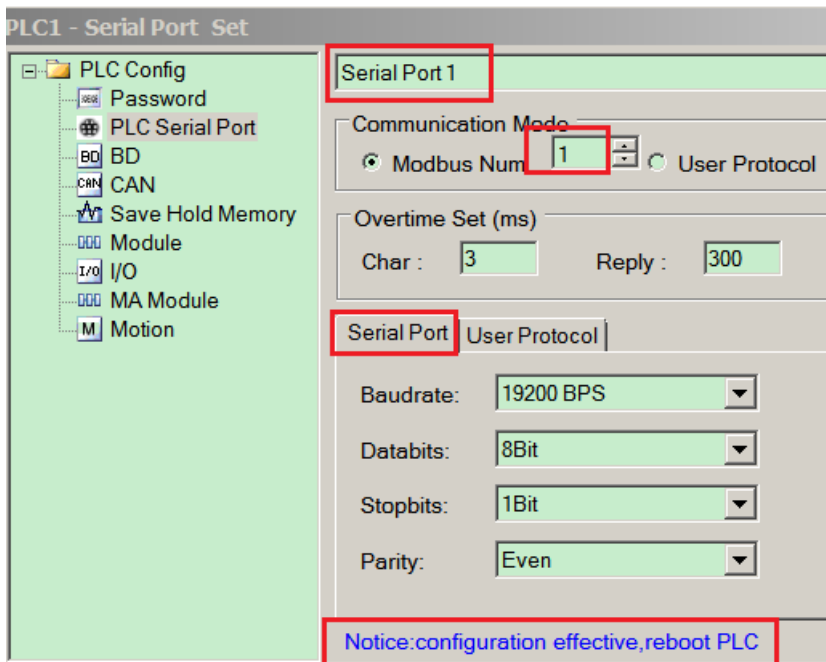

2.2.3 Cable making

(a) Connect to XC series PLC CPU (RS232 port)

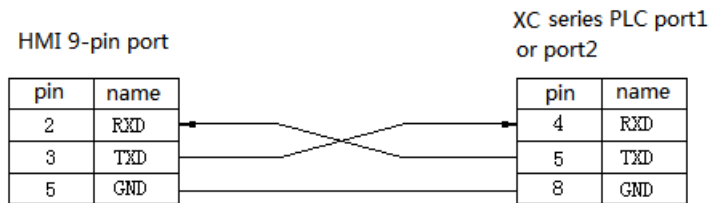

Fig1

(b) Connect to XC series PLC CPU (RS485 port)

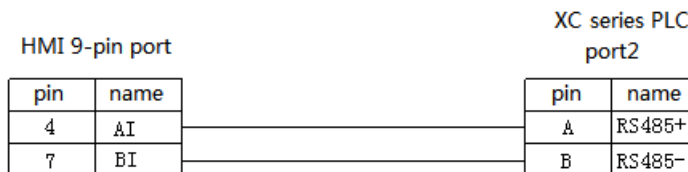

Fig2

(c) Connect via XC-RS485-BD (RS232)

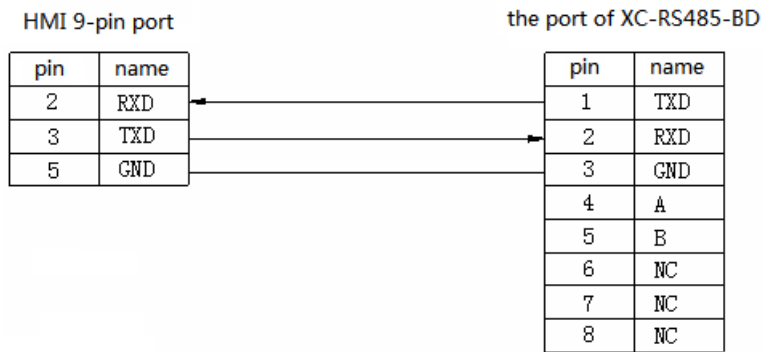

Fig3

(d) Connect via XC-RS485-BD (RS485)

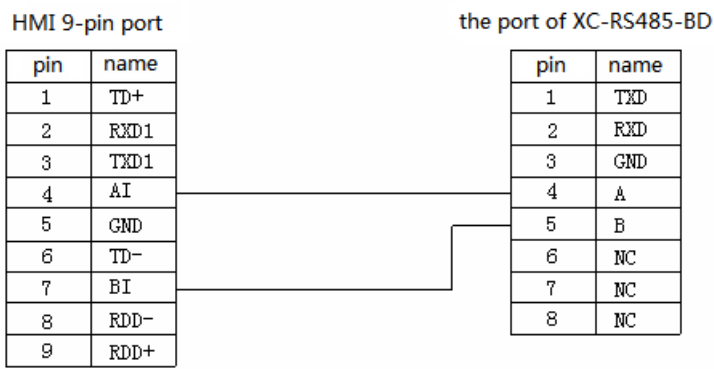

Fig4

2.2.4 Device address

PLC address	Range	Data type	Explanation
X	0~543	Bit	External input coil
Y	0~543	Bit	External input coil
M	0~7999	Bit	Internal coil
S	0~1023	Bit	Internal coil
M8XXX	0~511	Bit	Internal special register
T	0~639	Bit	Timer
C	0~639	Bit	Counter
D	0~7999	Word//DWord	Data register
TD	0~639	Word//DWord	Timer register
CD	0~639	Word//DWord	Counter register
D8XXX	0~511	Word//DWord	Special register
FD	0~1535	Word//DWord	FlashROM register
FD8XXX	0~511	Word//DWord	Output register
ED	0~36862	Word//DWord	Extend register
DM	7984	Word	Data register

DX	0~52	Word	Data register
DY	0~52	Word	Data register
DS	0~1008	Word	Data register
DM8XXX	0~496	Word	Data register
DT	0~603	Word	Data register
DC	0~619	Word	Data register
ID	0~9999	Word//DWord	Analog input
QD	0~9999	Word//DWord	Analog output

2.3 Mitsubishi FXseries PLC

2.3.1 Model

Series	CPU	Connected module	Port	Cable making	Device
FX	FX0N FX1N	CPU direct connection	RS422	Fig 1	Mitsubishi FX series PLC
	FX2N	RS232-BD	RS232	Fig 2	Mitsubishi FXBD(232\485)
	FX1S FX3U	RS485\422-BD	RS485	Fig 3	
			RS422		
	FX3G FX0 FX1	CPU direct connection	RS422	Fig 1	Mitsubishi FX series PLC
	FX2	CPU direct connection	RS422	Fig 4	Mitsubishi FX series PLC

2.3.2 Parameters

HMI settings:

Parameter	Recommend settings	Choices of settings	Item
PLC type	FX series		
Dat bit	7	7 or 8	
Stop bit	1	1 or 2	
Parity	Even parity	Even/odd/no parity	
Baud rate	9600	4800/9600/19200/38400/56000/57600/115200 /187500	
Station No.	0	0~255	

The default parameters of Mitsubishi FX series PLC: 9600, 7, 1, even, station No.0.

PLC settings:

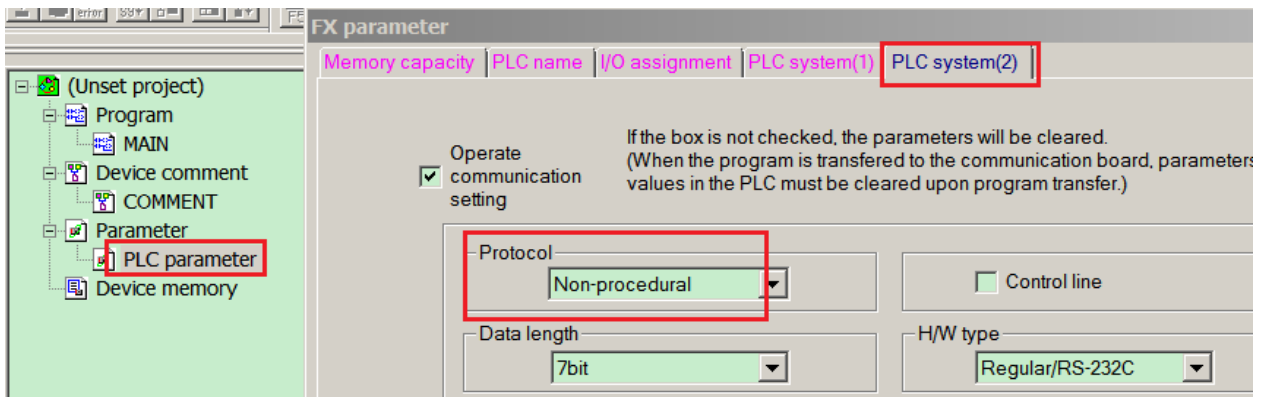

2.3.3 Cable making

(a) FX1N\2N\3U\3G\1S series PLC, RS422 port:

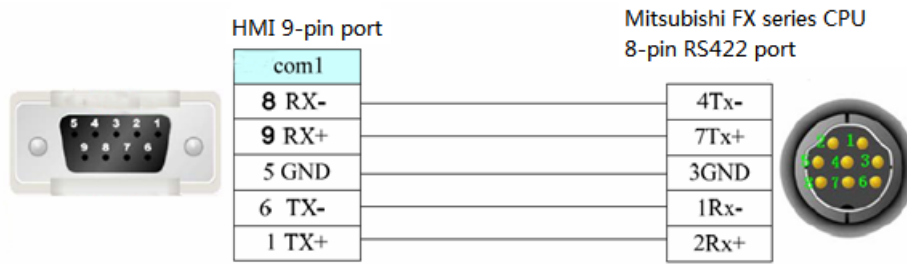

Fig1

(b) FX series PLC uses RS232-BD:

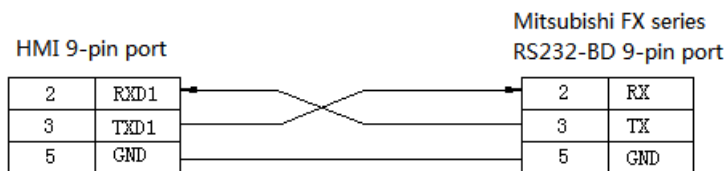

Fig2

(c) FX series PLC uses RS485BD:

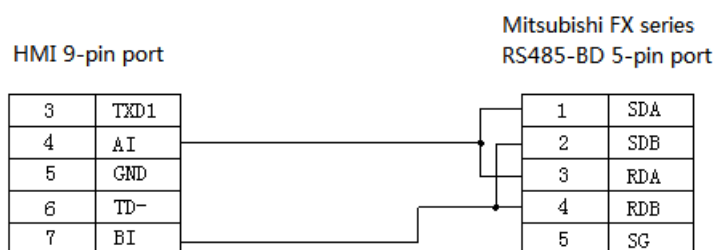

Fig3

(d) FX2 series PLC:

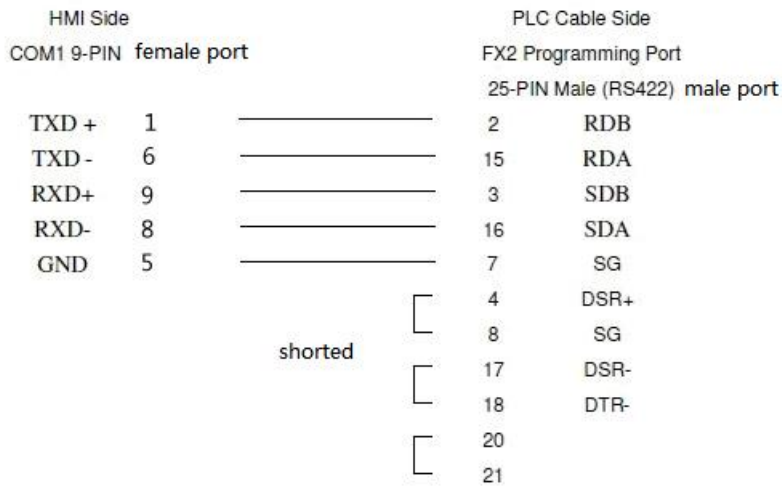

Fig4

2.3.4 Device address

PLC address	Range	Data type	Explanation
X	0~177	Bit	External input coil
Y	0~177	Bit	External output coil
M	0~8255	Bit	Internal coil
S	0~999	Bit	Stepper coil
T	0~255	Bit	Timer
C	0~255	Bit	Counter
C16	0~199	Word/DWord	16-bit counter
C32	200~255	DWord	32-bit counter
D	0~8255	Word/DWord	Data register
T	0~255	Word/DWord	Current value
X	0~177	Word/DWord	Data register
Y	0~177	Word/DWord	Data register
M	0~8255	Word/DWord	Data register
S	0~999	Word/DWord	Data register

2.4 Mitsubishi FX3U/G series PLC

2.4 .1 Model

Series	CPU	Connected module	Port	Cable	Choose PLC type in Touchwin software
FX	FX3U FX3G	CPU	RS422	Fig 1	Mitsubishi FX3U/G

2.4 .2 Parameters

HMI settings:

Parameter	Recommended settings	Choices of settings	Notes
PLC type	Mitsubishi FX3U/G series		
Data bit	7		
Stop bit	1		
Parity	Even parity		
Baud rate	9600	4800/9600/19200/38400/56000/57600/115200/187500	
Station no.	0		

The default parameters of Mitsubishi FX3U/G series PLC: 9600, 7, 1, even parity, station no.0

PLC settings:

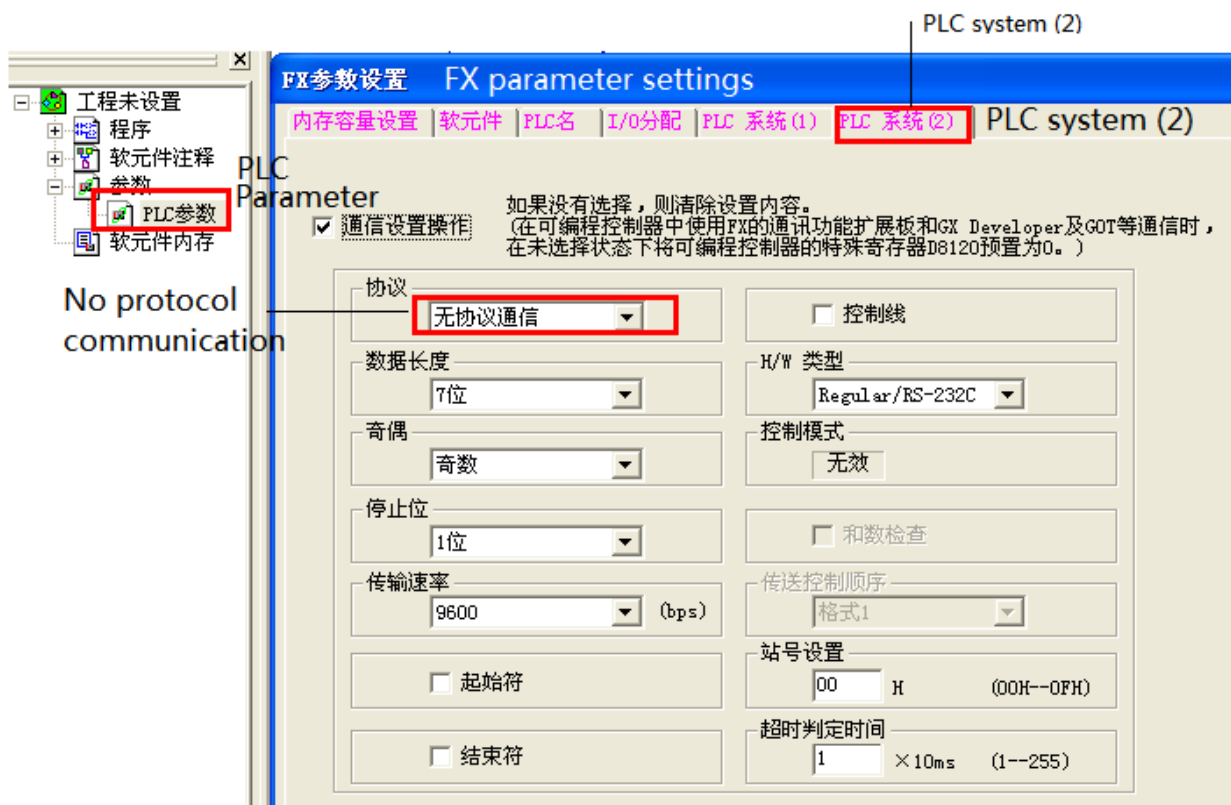

2.4 .3 Cable making

(a) FX3U\3G series PLC RS422:

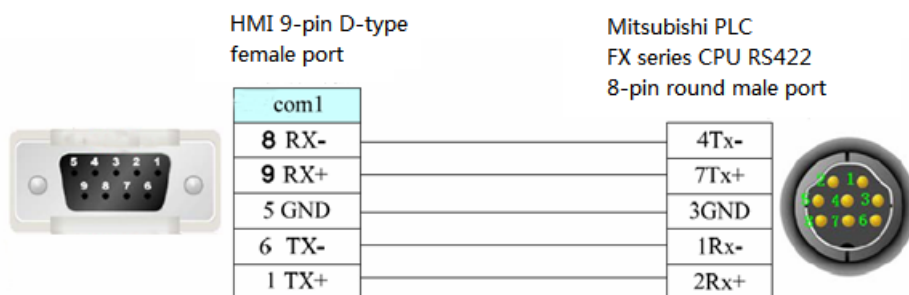

2.4 .4 Device address

PLC address	Range	Type	Explanation
X	0~177	Bit	External input terminal
Y	0~177	Bit	External output terminal

M	0~8255	Bit	Internal auxiliary coil
S	0~999	Bit	Stepper coil
T	0~255	Bit	Timer
C	0~255	Bit	Counter
C16	0~199	Word/DWord	16-bit counter
C32	200~255	DWord	32-bit counter
D	0~8255	Word/DWord	Data register
T	0~255	Word/DWord	Timer current value
X	0~177	Word/DWord	Used as data register
Y	0~177	Word/DWord	Used as data register
M	0~8255	Word/DWord	Used as data register
S	0~999	Word/DWord	Used as data register

2.5 Mitsubishi FX BD series PLC (RS232/485)

2.5.1 Device type

Series	CPU	Connected module	Port	Cable	PLC type in Touchwin software
FX	FX0N/1N/2N	232-BD	RS232	Fig1	Mitsubishi FX BD(232\485)
	FX1S FX3U/3G	485-BD	RS485	Fig2	

Note:

1. Do not hot plug the device!
2. The driver of 485-BD supports multi-station.

2.5.2 Parameters

HMI settings:

Parameters	Recommend settings	Choices of settings	Notes
PLC type	Mitsubishi FX BD(232\485)		
Data bit	7		
Stop bit	1		
Parity	Even parity		
Baud rate	9600	9600/19200/38400/56000/57600/ 115200/187500	
Station no.	0	0~255	

The default parameters of Mitsubishi FX BD (232/485): 9600, 7, 1, even parity, station no.0

PLC settings:

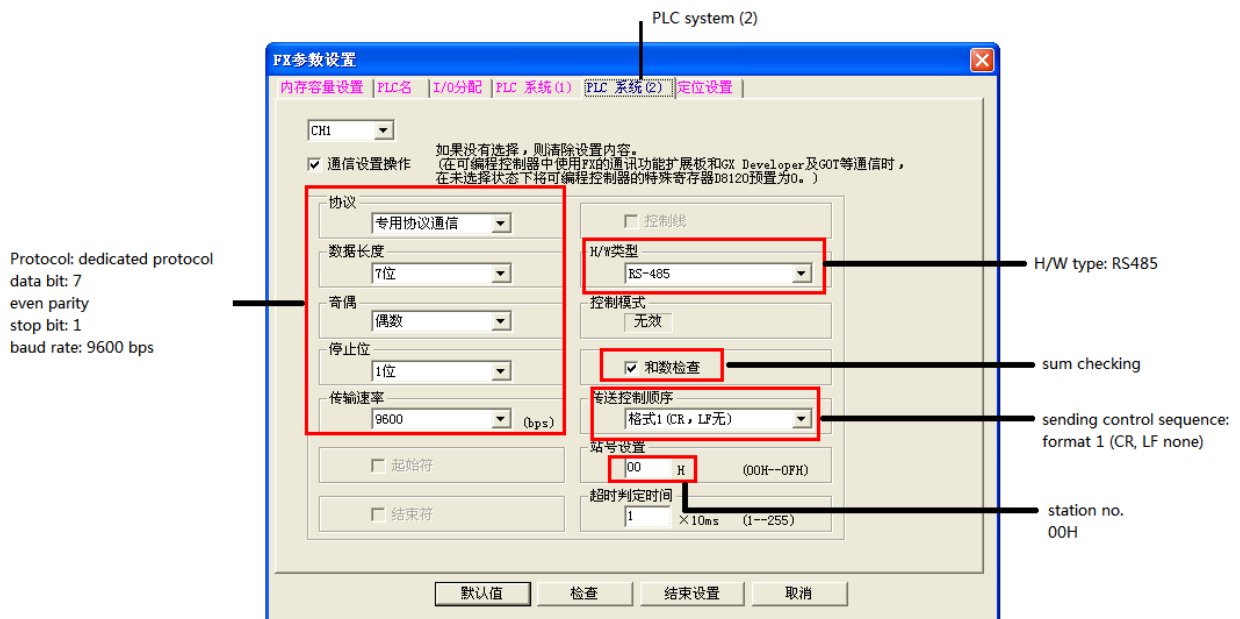

Note:

1. Please choose RS232 as H/W type when using 232-BD.
2. Please re-power on the PLC after changing the parameters.

2.5.3 Cable making

(a) FX series PLC RS232-BD:

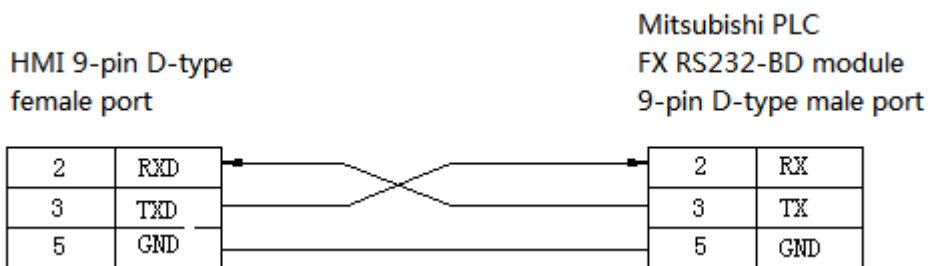

Fig1

(b) FX series PLC RS485-BD:

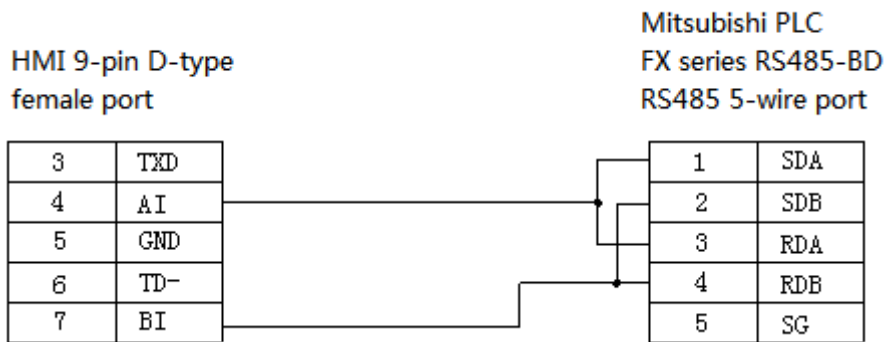

Fig2

2.5.3 Device address

PLC address	Range	Data type	Explanation
X	0~177	Bit	External input terminal
Y	0~177	Bit	External output terminal
M	0~8255	Bit	Internal auxiliary coil
S	0~999	Bi	Stepper coil
T	0~255	Bit	Timer
C	0~255	Bit	Counter
C16	0~199	Word/DWord	16-bit counter
C32	200~255	DWord	32-bit counter
D	0~8255	Word/DWord	Data register
T	0~255	Word/DWord	Current value
X	0~177	Word/DWord	Used as data register
Y	0~177	Word/DWord	Used as data register
M	0~8255	Word/DWord	Used as data register
S	0~999	Word/DWord	Used as data register

2.6 Mitsubishi Q series PLC

2.6.1 Model

MELSEC-Q series include the CPU unit of Q00, Q01, Q00U and so on. They can connect to the HMI via programmable port or communication module (QJ71C24N).

Series	CPU	Connected module	Port	Cable making	Device
Q	Q00 Q01 Q00U	CPU direct connection	RS232	Fig 1	Mitsubishi Q series
	Q00J, Q00, Q01, Q02H, Q06H, Q12H, Q25H, Q12PH, Q25PH	Serial communication module QJ71C24	RS232	Fig 2	Mitsubishi Q series
			RS422	Fig 3	

2.6.2 Parameters

HMI settings:

Parameter	Recommend setting	Choices of settings	Item
PLC type	Q series		
Data bit	8	7 or 8	
Stop bit	1	1 or 2	
Parity	Odd parity	Even/odd/no parity	
Baud rate	19200	4800/9600/19200/38400/56000/57600/115200/187500	
Station No.	0	0~255	

The default parameter of Q series PLC: 19200, 8, 1, odd parity, station No.0.

PLC settings:

1. Q01\Q00 PLC:

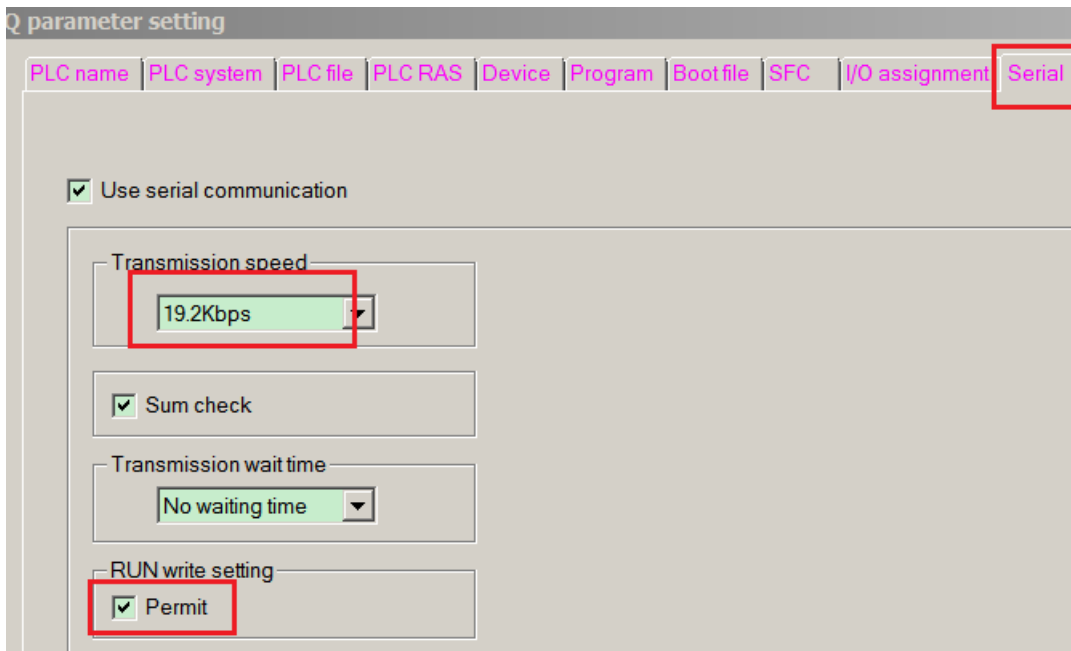

2. QJ71C24N serial port module

QJ71C24N can connect to CPU and communicate with other devices. Such as Q02CPU, the settings are as the following:

PLC software version v8.26

(a) Double click PLC parameter, choose I/O assignment:

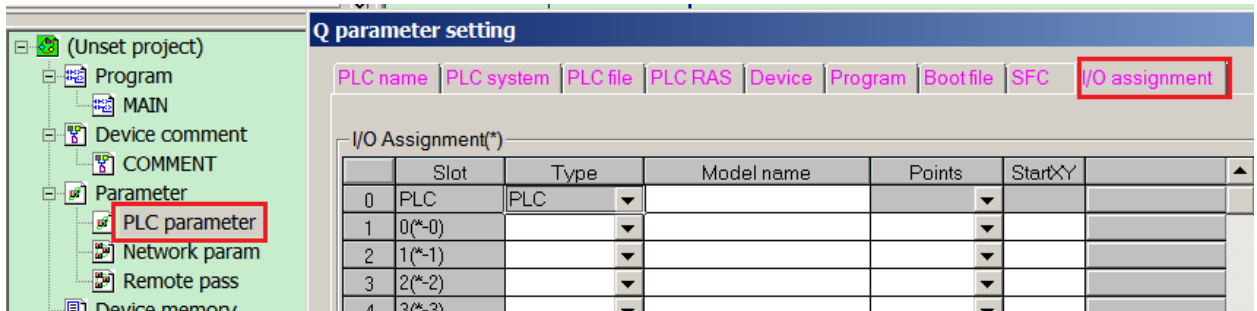

(b) Change the type of item1 to intelli.

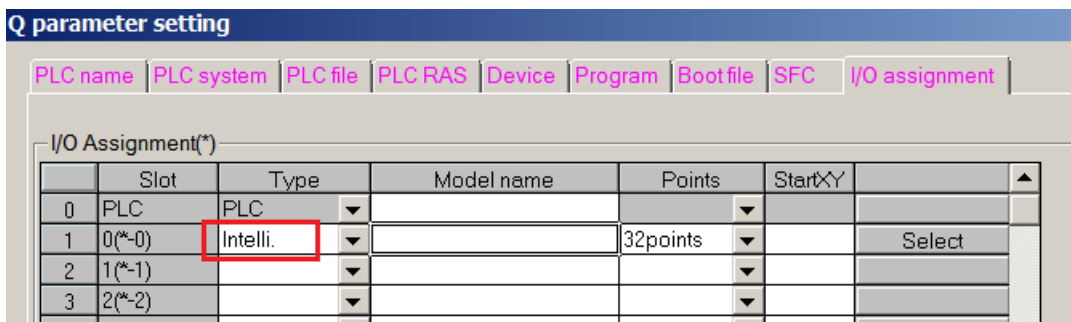

(c) Click “switch setting” :

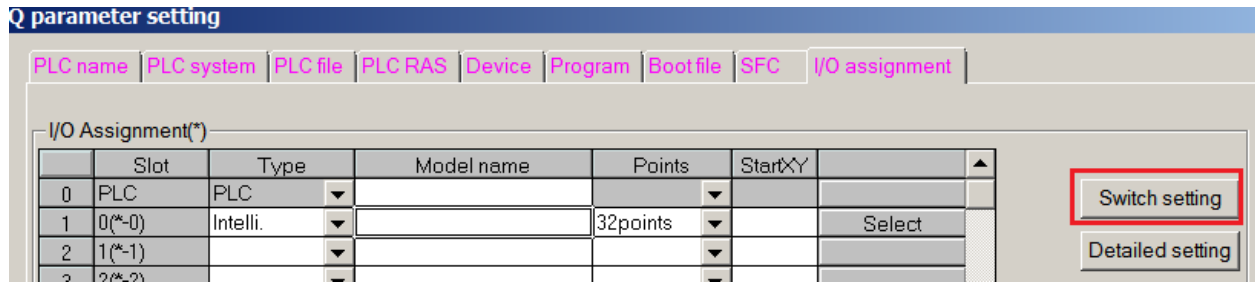

(d) Set the parameter as the following window:

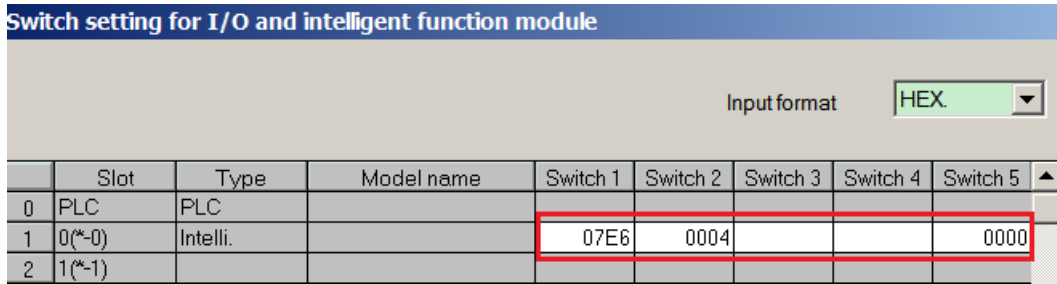

(e) Click End button to finish the settings, then repower on the PLC.

PLC software version v8.8:

For QJ71C24 module RS232, please set the parameter of CH1:

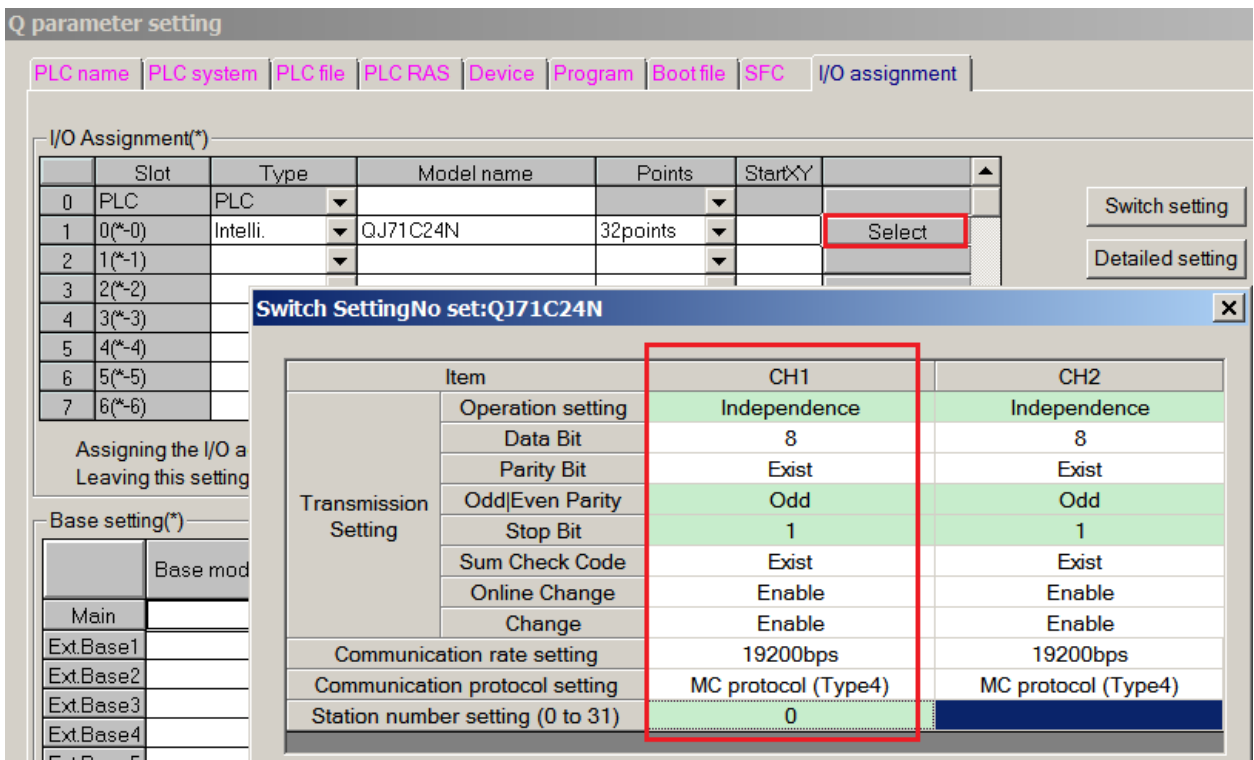

For QJ71C24 module RS422, please set the parameter of CH2:

Q parameter setting

PLC name | PLC system | PLC file | PLC RAS | Device | Program | Boot file | SFC | I/O assignment

I/O Assignment(*)

Slot	Type	Model name	Points	StartXY
0	PLC			
1	Q(*-0)	Intelli.	QJ71C24N	32points
2	1(*-1)			
3	2(*-2)			
4	3(*-3)			
5	4(*-4)			
6	5(*-5)			
7	6(*-6)			

Switch setting

Detailed setting

Switch Setting No set: QJ71C24N

Item	CH1	CH2
Operation setting	Independence	Independence
Data Bit	8	8
Parity Bit	Exist	Exist
Odd Even Parity	Odd	Odd
Stop Bit	1	1
Sum Check Code	Exist	Exist
Online Change	Enable	Enable
Change	Enable	Enable
Communication rate setting	19200bps	19200bps
Communication protocol setting	MC protocol (Type4)	MC protocol (Type4)
Station number setting (0 to 31)	0	

Assigning the I/O a
Leaving this setting

Base setting(*)

Base mod
Main
Ext.Base1
Ext.Base2
Ext.Base3
Ext.Base4

2.6.3 Cable making

(a) Q series PLC CPU unit, RS232 port:

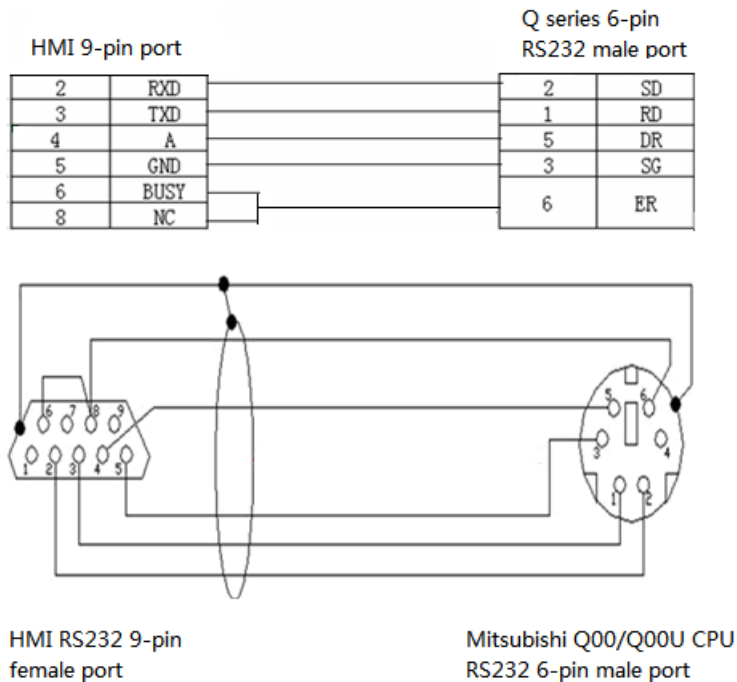

Fig1

(b) Q series PLC uses QJ71C24N module RS232:

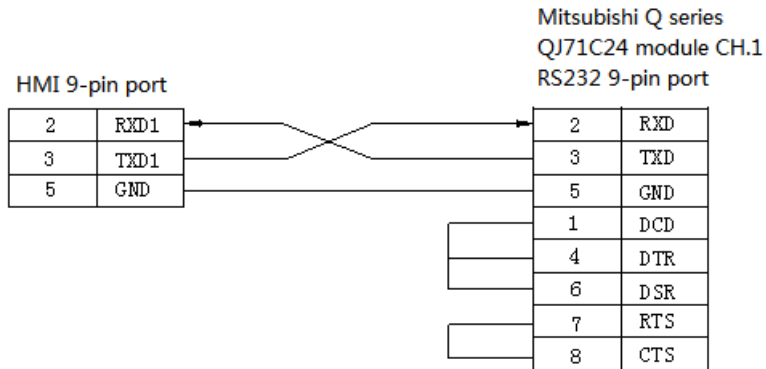

Fig2

(c) Q series PLC uses QJ71C24 module RS422:

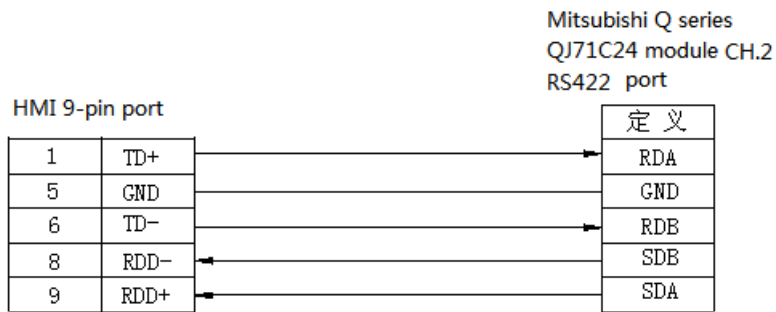

Fig3

2.6.4 Device address

PLC address	Range	Data type	Explanation
X	0~177	Bit	External input coil
Y	0~177	Bit	External output coil
M	0~8255	Bit	Internal coil
S	0~999	Bit	Stepper coil
T	0~255	Bit	Timer
C	0~255	Bit	Counter
C16	0~199	Word/DWord	16-bit counter
C32	200~255	DWord	32-bit counter
D	0~8255	Word/DWord	Data register
T	0~255	Word/DWord	Current value
X	0~177	Word/DWord	Data register

Y	0~177	Word/DWord	Data register
M	0~8255	Word/DWord	Data register
S	0~999	Word/DWord	Data register

2.7 Siemens S7-200 series PLC

2.7.1 Model

Series	CPU	Connected module	Port	Cable	Device
S7-200	CPU212, CPU221, CPU222, CPU224, CPU226	Connect CPU RS485 port directly	RS485	Fig 1	Siemens S7-200

2.7.2 Parameters

HMI:

Parameters	Recommend settings	Choices of settings	Item
PLC type	S7-200		
Port	RS485	RS485	
Data bit	8	7 or 8	
Stop	1	1 or 2	
Parity	Even parity	Even/odd/no parity	
Baud rate	9600	4800/38400/9600/115200/19200/187500	
Station no.	2		Must use recommend settings

The default communication parameters of Siemens S7-200 series PLC: 9600, 8, even parity, station No.2.

PLC settings:

Notes:

1. Siemens PLC has 3 kinds of registers: 8-bit VB, 16-bit VW and 32-bit VD.
2. The space of registers are overlapped, the address of VW must be even numbers, for example: VW0, VW2....., the address of VD must be the multiple of 4, such as VD0, VD4, VD8.....
3. Please use registers copy function to send PSW data to VW (single word).
4. Please use register copy function to send PSW data(single word) to VD(double words).

2.7.3 Cable making

HMI connects to S7-200 via RS485:

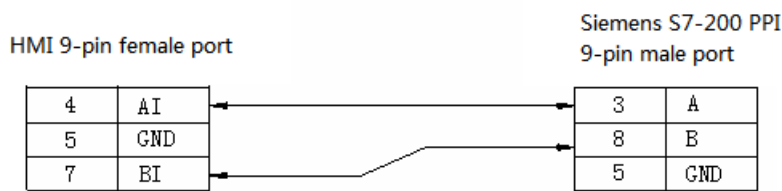

Fig1

2.7.4 Device address

SIMATIC S7-200 series

PLC address	Range	Data type	Explanation
VB	0~4095	Byte	variable byte data register
VW	0~4095	Word	variable word data register
VD	0~4095	DWord	variable double word data register
IB	0~15	Byte	External input byte reflection register
IW	0~15	Word	External input word reflection register
ID	0~15	DWord	External input double words reflection register
QB	0~15	Byte	External output byte reflection register
QW	0~15	Word	External output word reflection register
QD	0~15	DWord	External output double words reflection register
MB	0~31	Byte	Internal auxiliary byte register
MW	0~31	Word	Internal auxiliary word register
MD	0~31	DWord	Internal auxiliary double words register
SMB	0~299	Byte	Internal special auxiliary byte register
SMW	0~299	Word	Internal special auxiliary word register
SMD	0~299	DWord	Internal special auxiliary double words register
SB	0~31	Byte	Special auxiliary byte register
SW	0~31	Word	Special auxiliary word register
SD	0~31	DWord	Special auxiliary double words register
T	0~255	Word	Register
C	0~255	Word	Register
M	0~31	Bit	Bit register
V	0~4095	Bit	Variable register
I	0~15	Bit	External input coil
Q	0~15	Bit	External output coil
SM	0~299	Bit	Special relay
S	0~31	Bit	Sequence relay
T	0~255	Bit	Timer
C	0~255	Bit	Counter

2.8 Siemens S7-300/400 series PLC

2.8.1 Model

SIMATIC S7-300/400 PLC (connect to CPU directly)

Series	CPU	Connected module	Port	Cable	Device
S7-300	CPU312, CPU314, CPU315	RS485 port of CPU	RS485	fig 1	Siemens SIMATIC S7-300/400 PLC
S7-400	CPU412-1, CPU412-2, CPU414-2,				

2.8.2 Parameters

HMI settings:

Parameter	Recommend settings	Choice of settings	Note
PLC type	S7-300/400		
Port	RS485		
Data bit	8	7 or 8	
Stop bit	1	1 or 2	
Parity	Even parity	Even/odd/no parity	
Baud rate	19200	4800/38400/9600/115200/19200/187500	
Station no.	2		Please use recommend settings

The default parameters of Siemens S7-300\400: 19200, 8, even parity, station No.2.

PLC settings:

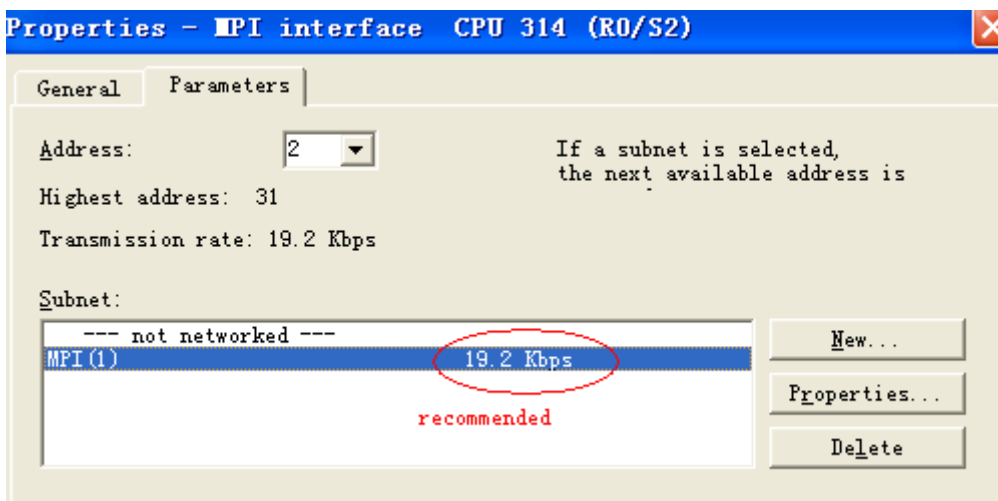
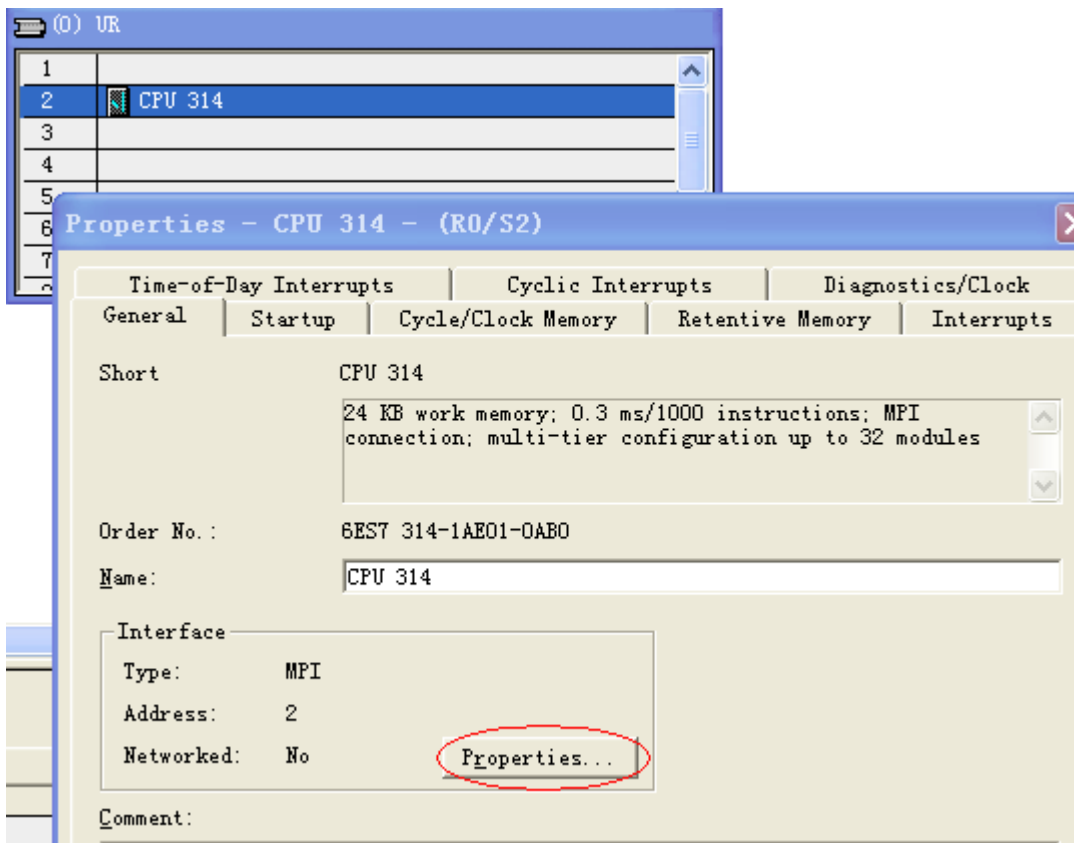

Communication notes for S7-300:

1. Siemens baud rate must set to 19200 kbps; don't set the parameters of PG/PC adapter.
2. Don't modify the "panel station no." in the Touchwin software.

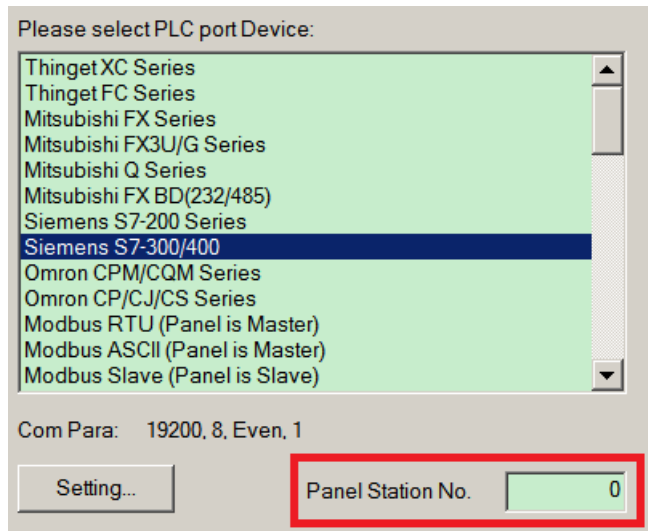

3. Cable: no need PG/PC adapter;
4. Please define the DB register in the PLC when testing the communication.
5. Please note that the port will be operated in PLC program by accident.
6. The default station No. of S7-300 is 2, please don't modify it.

Example: MPI port of S7-300 connects to HMI, the PLC connects to SCADA software via Ethernet module, PLC station no. is 8, module station no. is 3, HMI station no. is 0. The result is that communication between SCADA and PLC will be cut off. Because the HMI cannot find other devices and modules cannot be inserted in. please change the PLC station no. to 2. These devices can form a loop:

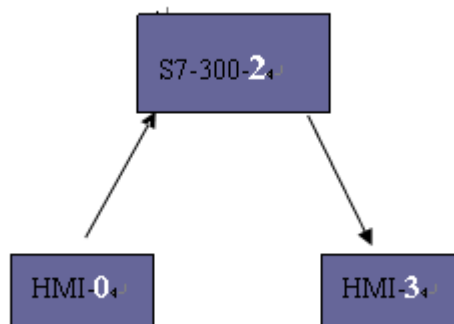

2.8.3 Cable making

HMI connects to S7-300/400 via RS485:

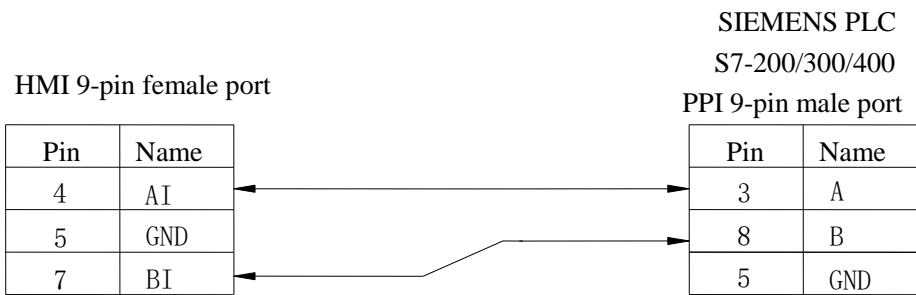

Fig1

2.8.4 Device address

SIMATIC S7-300/400

PLC type	Range	Data type	Explanation
I	0~9999	Byte/Word/DWord	External input register
Q	0~9999	Byte/Word/DWord	External output register
M	0~9999	Byte/Word/DWord	Internal auxiliary register
DB0~DB20	0~9999	Byte/Word/DWord	Data register
I	0~9999	Bit	External input coil
Q	0~9999	Bit	External output coil
M	0~9999	Bit	Internal auxiliary relay
DB0~DB20	0~9999	Bit	Internal auxiliary relay

2.9 OMRON SYSMAC series PLC

OMRON CPM1A, CQM1-CPU series CPU cannot support RS232. It can connect to the Touchwin HMI via CPM1-CIF01 adapter and modules including C500-LK203, C120-LK201-V1, C500-LK201-V1. The PLC uses Hostlink protocol when communicating. Please change the PLC startup choice to MONITOR RUN.

2.9.1 Device model

Series	CPU	Connected module	Communication mode	Cable	The PLC device in TouchWin
CP	CP1E-30N CP1H CP1L	CPU direct connection	RS232	Fig 1	Omron CP/CJ/CS
		Module CP1W-CIF11	RS485	Fig 2	
		Module CP1W-CIF11	RS422	Fig 3	
CJ	CJ1 CJ1G-CPU44 CJ1G-CPU45 CJ2M-CPU11	CPU direct connection	RS232	Fig 1	
CS1	CS1H-CPU63/64/65/66/67 CS1G-CPU42/43/44/45 CS1G-CPU42H CS1G-CPU43H CS1G-CPU44H CS1G-CPU45H CS1H-CPU63H CS1H-CPU64H CS1H-CPU65H CS1H-CPU66H CS1H-CPU67H	CPU direct connection	RS232	Fig 1	

Series	CPU	Connected module	Communication mode	Cable	The PLC device in TouchWin
C	C200HE C200HX	CPU direct connection	RS232	Fig 1	Omron CPM/CQM
	C1000HF	C500-LK203 (communication module)			

	C2000	C120-LK201-V1(communication module)		
		C500-LK201-V1(communication module)		
		C500-LK203(communication module)		
CPM	CPM2A CPM2AE CPM2AH-40CDR-A CPM1H	CPU direct connection	RS232	Fig 1
	CPM1A	OMRON CIF01 (RS232) Communication adapter		
CQM	CQM1H-CPU21	CPU direct connection		
	CQM1-CPU	OMRON CIF01 (RS232) Communication adapter		

2.9.2 Parameters

HMI:

The default parameters of OMRON CP/CJ/CS series PLC: 9600, 7, 2, even parity, station no.0.

The default parameters of OMRON CPM/CQM series PLC: 9600, 7, 2, even parity, station no.0.

Parameter	Recommended settings	Choices of settings	Notes
PLC type	OMRON CPM/CQM series OMRON CP/CJ/CS series	OMRON CP/CJ/CS series OMRON CPM/CQM series	
Port	RS232	RS232/RS485	
Data bit	7	7 or 8	
Stop bit	2	1 or 2	
Parity	Even parity	Even/odd/ no parity	
Baud rate	9600	4800/38400/9600/115200 /19200/187500	
Station no.	0	0~255	

2.9.3 Cable making

(a) CPU RS232 port:

OMRON PLC
 CPU CPM1-CIF01/C500-LK203
 C120-LK201-V1/C500-LK203

HMI 9-pin female port

RS232 9-pin male port

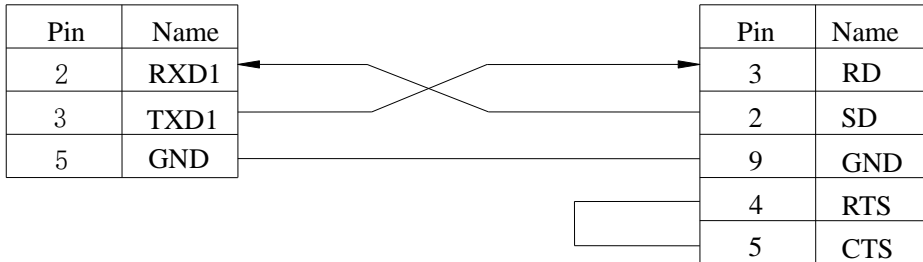

Fig1

(b) Through module CP1W-CIF11 RS485:

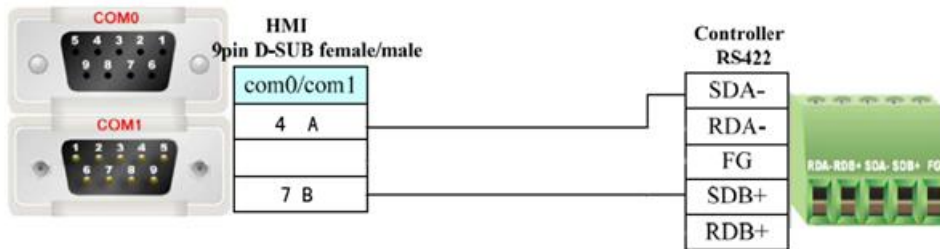

Fig2

Note: If OMRON RS485 module CPIW-CIF11 uses 485-2 connection mode, turn OFF the SW1 switch on the module, turn ON SW2, 3, 5, 6. SW4 is selectable.

(c) Through the module CP1W-CIF11 RS422:

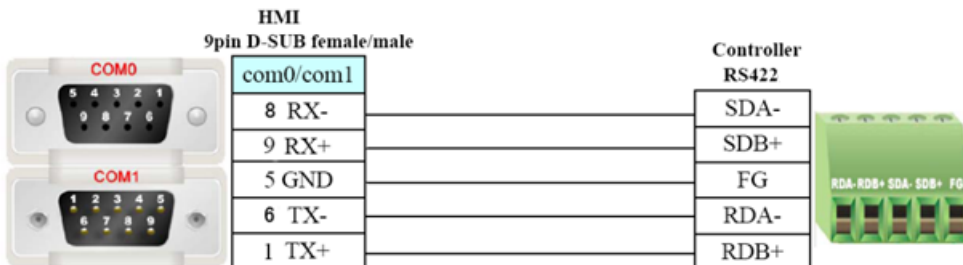

Fig3

Note: If OMRON RS485 module CP1W-CIF11 uses RS422 connection mode, turn OFF the SW1~6 on the module.

2.9.4 Device address

(a) SYSMAC CPM/CQM series

PLC address	Range	Data type	Explanation
IR	0~65535	Bit	I/O and internal relay
SR	244~65535	Bit	Relay
HR	0~65535	Bit	Holding relay
AR	0~65535	Bit	Auxiliary relay
LR	0~65535	Bit	Link relay
PV	0~65535	Bit	Current value of timer and counter
TC	0~65535	Bit	Timer and counter
IR	0~65535	Word/DWord	Register
SR	244~65535	Word/DWord	Register
HR	0~65535	Word/DWord	Register
AR	0~65535	Word/DWord	Register
LR	0~65535	Word/DWord	Register
PV	0~65535	Word/DWord	Register
TC	0~65535	Word/DWord	Register
DM	0~65535	Word/DWord	Data register (single/double words)

(b) SYSMAC CP/CJ/CS series

PLC address	Range	Data type	Explanation
CIO	0~9999	Bit	
D	0~99999	Bit	
H	0~9999	Bit	
W	0~9999	Bit	
A	0~9999	Bit	
T	0~9999	Bit	Timer
C	0~9999	Bit	Counter
CIO	0~9999	Word/DWord	Register
D	0~99999	Word/DWord	Register
H	0~9999	Word/DWord	Register
W	0~9999	Word/DWord	Register
A	0~9999	Word/DWord	Register
T	0~9999	Word/DWord	Register
C	0~9999	Word/DWord	Register

2.10 Koyo S series PLC

Koyo KOSTA-S and Direct-Logic series PLC

2.10.1 Device model

(a) Koyostac S series SH\SM\SN PLC (direct connect to the CPU module)

Series	CPU	Connected module	Port	Cable	Device
SH series	SH-48RS	CPU	RS232	Fig1	Koyo S series
SM series	SM24-T				
SN series					
SU-6		CPU	RS232	Fig1	
SU-6B			RS232	Fig1	
			RS422	Fig3	

Note: Koyo SH-48RS doesn't have Run, Stop switch, but only have one AMP port.

(b) Koyo Kostac S series SG-8, SU-5, SU-6, SR-21, SR-22... PLC (use communication module)

CPU	Connected module	Port	Cable	Device
SG-8	G01-DM communication unit	RS232	Fig 1	Koyo S series
		RS422	Fig 3	
SU-5	U01-DM communication unit	RS232	Fig 1	
SU-6	U01-DM communication unit			
SR-21	E-02DM-R1 communication unit	RS422	Fig 3	
SR-22				

(c) Koyo Direct Logic series DL05, DL250...PLC (connect to CPU directly)

Series	CPU	Connected module	Port	Cable	Device
Direct Logic	DL05 DL105 DL230 DL240 DL250 DL350 DL450	Connect to RJ-11port(RS232) of CPU	RS232	Fig 2	Koyo S series
	DL250	Connect to the port of CPU	RS422	Fig 3	

	DL430	Connect to the port of CPU			
	DL440				
	DL450			RS232	Fig 2
	DL350				

Note: port2 of DL250CPU has RS232 and RS422; please identify them when making the cable.

2.10.2 Parameters

HMI:

Parameter	Recommend settings	Choices of settings	Notes
PLC	Koyo S series PLC		
Port	RS232	RS232 or RS422	
Data bit	8	7 or 8	
Stop bit	1	1 or 2	
Parity	Odd parity	Even/odd/no parity	
Baud rate	9600	4800/38400/9600/115200/19200/187500	
Station no.	0	0~255	

The default communication parameters of Koyo S series PLC: 9600, 8, 1, odd parity, station no.0.

PLC:

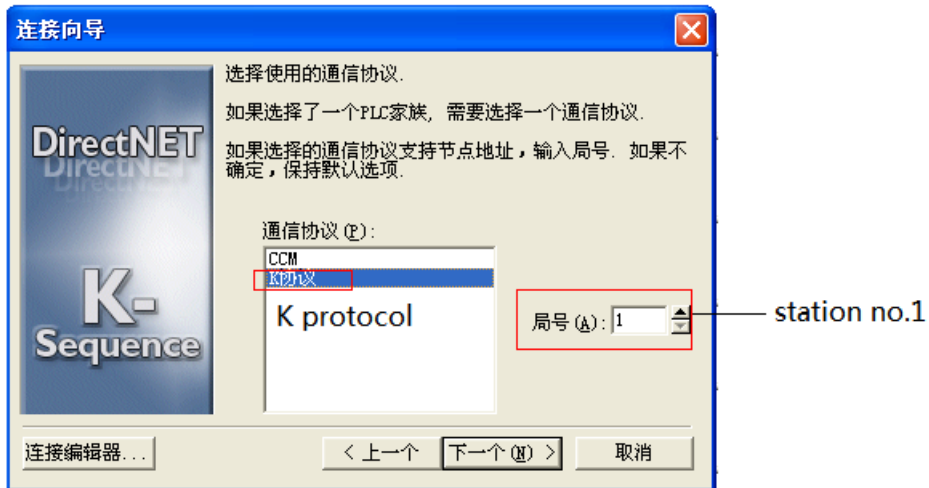



serial port: COM1
 baud rate: 9600
 odd parity

PLC: SH/SH1
 K protocol
 station no.1

Note: 1. Koyo K protocol cannot modify station no., the station no. is 0 in the HMI.

2. The register address starts from R2000.

2.10.3 Cable making

(a) RS232 25-pin port on CPU or communication unit:

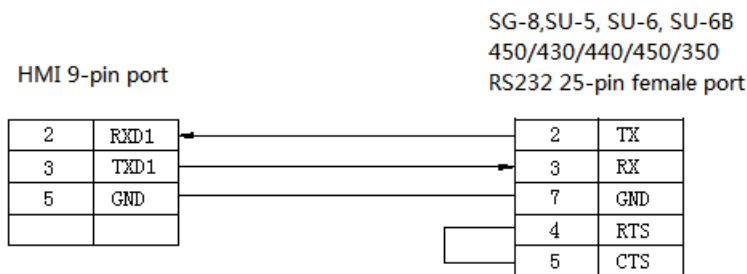

Fig1

RJ-11 6-pin RS232 female port on the CPU:

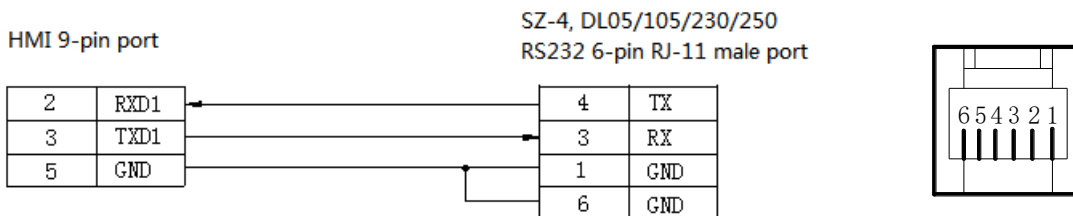

Fig2

RS422 connection:

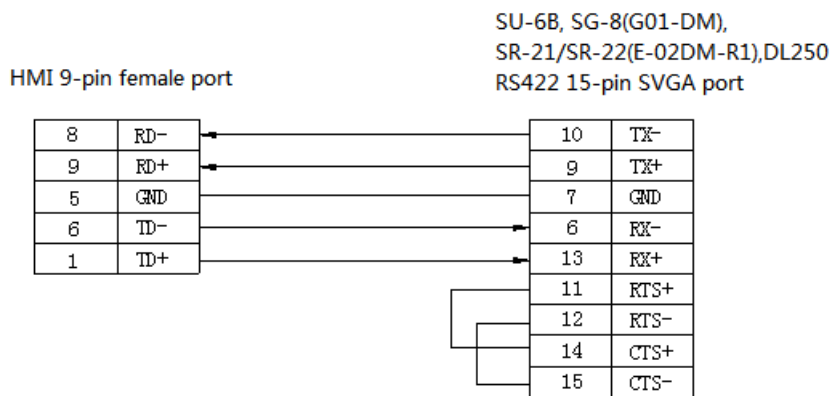

Fig3

2.10.4 Device address

PLC address	Range	Data type	Explanation
M	0~777	Bit	Internal auxiliary coil
I	0~777	Bit	External input coil
Q	0~777	Bit	External output coil
SP	0~777	Bit	Internal auxiliary coil
T	0~777	Bit	Timer
C	0~777	Bit	Counter
S	0~777	Bit	Stepper coil
R	0~41200	Word/DWord	Data register

2.11 Koyo DL series PLC

2.11.1 Device type

Koyo Direct Logic series DL05, DL250 PLC (direct connect to CPU)

Series	CPU	Connected module	Port	Cable	Choose PLC type in Touchwin software
Direct Logic	DL05	Connect to CPU RJ-11 port	RS232	Fig 1	Koyo DL series
	DL105				
	DL230				
	DL240				
	DL250	Connect to CPU com port	RS422	Fig 2	
	DL350				
	DL430				
	DL440				
DL450					

Note: the port2 of DL250 has RS232 and RS422, please identify the cable connection for them.

2.11.2 Parameters

HMI settings:

Parameters	Recommend settings	Choices of settings	Note
PLC type	Koyo DL series		
Port	RS232	RS232/RS422	
Data bit	8	7/8	
Stop bit	1	1/2	
Parity	Odd parity	Even /odd /no parity	
Baud rate	9600	4800/38400/9600/115200/19200/187500	
Station no.	0	0-255	

2.11.3 Cable making

RS232 Connection:

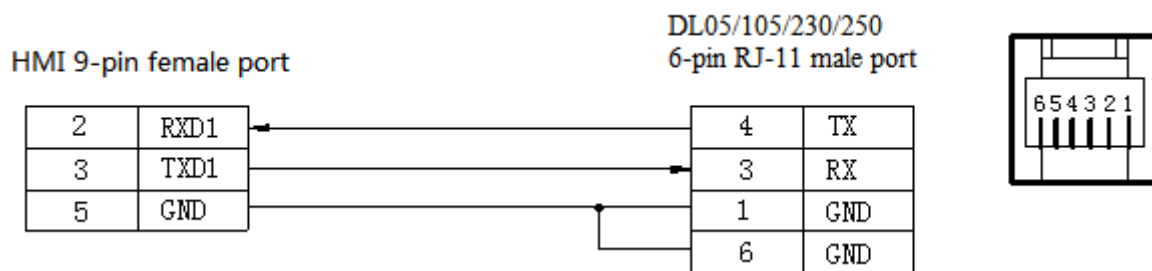

Fig1

RS422 connection:

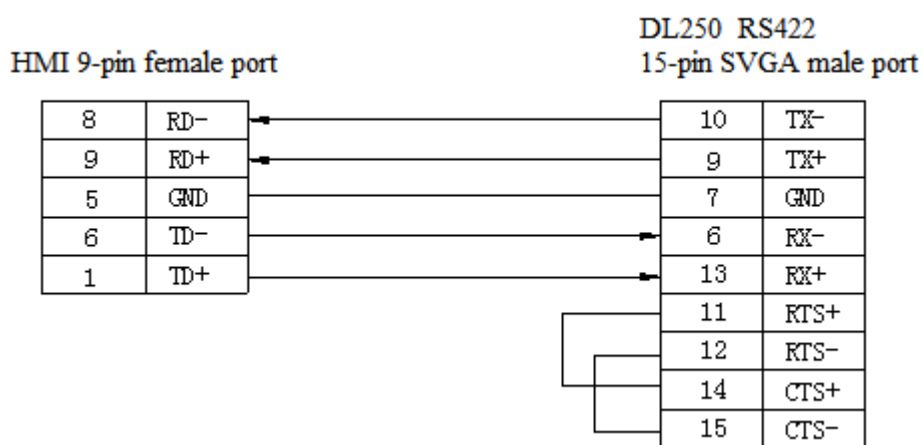

Fig2

2.11.4 Device address

Device address	Range	Data type	Explanation
V	0~41200	Word/DWord	Data register
C	0~777	Bit	Counter
X	0~777	Bit	Input
Y	0~777	Bit	Output
SP	0~777	Bit	Auxiliary relay
T	0~777	Bit	Timer
CT	0~777	Bit	Counter
S	0~777	Bit	Auxiliary relay
V	0.0~41200.15	Bit	Auxiliary relay

2.12 Delta DVP series PLC

2.12.1 Model

Delta DVP series	CPU	Connected module	Port	Cable	Deivce
ES\EH\EX		Direct connect to the CPU	RS232	Fig 1	Delta DVP series
			RS485	Fig 2	
SS\SA\SC\SX			RS232	Fig 1	
			RS485	Fig 2	

2.12.2 Parameters

HMI:

Parameters	Recommend settings	Choices of settings	Notes
PLC type	Delta DVP series		
Port	RS232	RS232 or RS485	
Data bit	7	7 or 8	
Stop bit	1	1 or 2	
Parity	Even parity	Even/odd/no parity	
Baud rate	9600	4800/38400/9600/115200/19200/187500	
Station no.	1	0~255	

The default communication parameters of Delta DVP series PLC: 9600, 7, 1, even parity, station no.1.

2.12.3 Cable making

(a) The RS232 port on CPU:

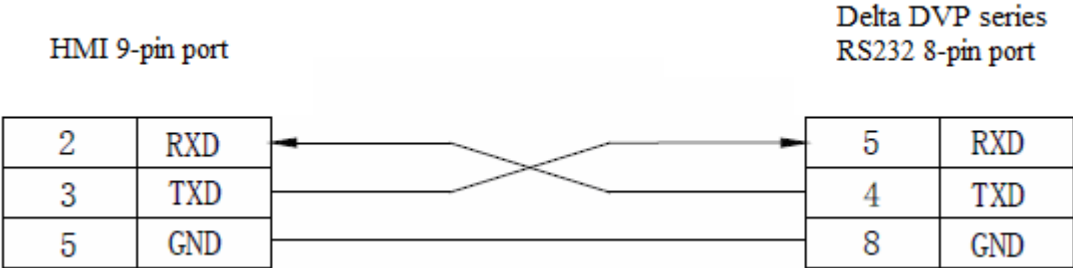

Fig 1

(b) RS485 port on the CPU:

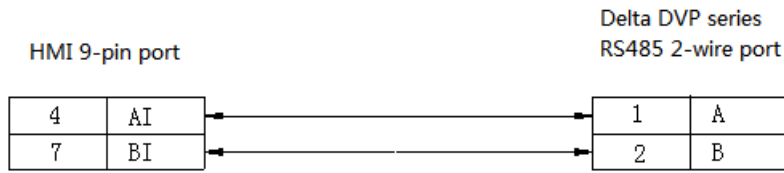

Fig2

2.12.4 Device address

PLC address	Range	Data type	Explanation
X	0~377	Bit	External input coil
Y	0~377	Bit	External output coil
M	0~1279	Bit	Internal auxiliary relay
S	0~1023	Bit	Stepper coil
T	0~255	Bit	Timer
C	0~255	Bit	Counter
D	0~1279	Word/DWord	Data register
TD	0~255	Word/DWord	Current value of timer
CD	0~255	Word/DWord	Current value of counter
S	0~1023	Word/DWord	Data register
X	0~377	Word/DWord	Data register
Y	0~377	Word/DWord	Data register
M	0~127	Word/DWord	Data register

2.13 LG Master-K(CPU Direct) series PLC

LG Master-K series PLC support CPU(RS232) and Cnet module communication mode. This chapter will introduce CPU mode.

2.13.1 Device model

Series	Connected module	Port	Cable	Device
K80 K120	CPU	RS232	Fig 1	LG Master-K80/120 series

Note: before communicating, please write “END” instruction to the PLC. Otherwise, the PLC will report an error and the ERR LED will light.

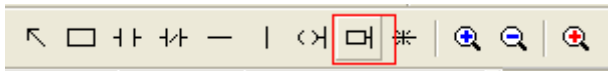

2.13.2 Parameters

HMI:

Parameters	Recommend settings	Choices of settings	Notes
PLC type	LG Master-K80/120 series PLC		
Port	RS232	RS232	
Dat bit	8	7 or 8	
Stop bit	1	1 or 2	
Parity	No parity	Even/odd/no parity	
Baud rate	38400	4800/38400/9600/115200/19200/187500	
Station no.	0	0~255	

The default communication parameters of LG Master K: 38400, 8, 1, no parity, station no.0.

PLC:



2.13.3 Cable making

Master-K 80\120 RS232:

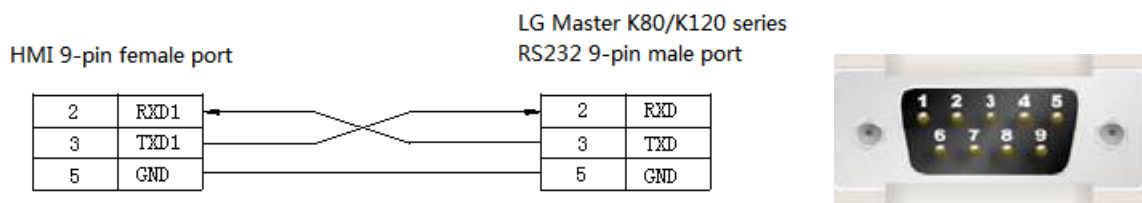

Fig1

2.13.4 Device address

LGMaster-K80/120 series PLC

PLC address	Range	Data type	Explanation
M	0~9999F	Bit	Internal auxiliary relay
L	0~9999F	Bit	Link relay
K	0~9999F	Bit	Holding relay
T	0~9999	Bit	Timer
C	0~9999	Bit	Counter
P	0~9999F	Bit	I/O coil
D	0~9999	Word/DWord	Data register
TD	0~9999	Word/DWord	Current value of timer

CD	0~9999	Word/DWord	Current value of counter
S	0~9999	Word/DWord	Used as register
K	0~9999	Word/DWord	Used as register
M	0~9999	Word/DWord	Used as register
L	0~9999	Word/DWord	Used as register
F	0~9999	Word/DWord	Used as register
P	0~9999	Word/DWord	Used as register

2.14 LG Master-K(Cnet) series PLC

LG Master-K80/120 series PLC Cnet communication module

LG Master-K series PLC support CPU(RS232) and Cnet expansion port communication mode. This chapter will introduce Cnet mode.

2.14.1 Device model

Series	Connected module	Port	Cable	Device
K80	Cnet communication module	RS232	Fig 1	LG Master-K80/120 (Cnet) series
K120		RS485	Fig 2	

Note:

- 1. For Master K-cnet communication, turn ON DIP switch 2, turn OFF DIP switch 1. For LG Master KxxxS communication, keep the DIP switch to default settings.**
- 2. LG Master KxxxS CPU only supports RS232 connection. Cnet communication module supports RS232 and RS485 connection.**

2.14.2 Parameters

HMI:

Parameters	Recommend settings	Choices of settings	Notes
PLC type	LG Master-K80/120 (Cnet) series PLC		
Port	RS232	RS232	
Data bit	8	7 or 8	
Stop bit	1	1 or 2	
Parity	Even parity	Even/odd/no parity	
Baud rate	9600	4800/38400/9600/115200 /19200/187500	
Station no.	1	0~255	

The default parameters of LG Master K-cnet : 9600, 8, 1, even parity, station no.1.

PLC:

Notes:

- 1. Turn on the switch BUILT-IN CNET on the PLC.**
- 2. Choose the correct channel, protocol and mode.**

0-RS232 communication:



1-RS485 communication:



2.14.3 Cable making

(a) Master K-net protocol RS232:

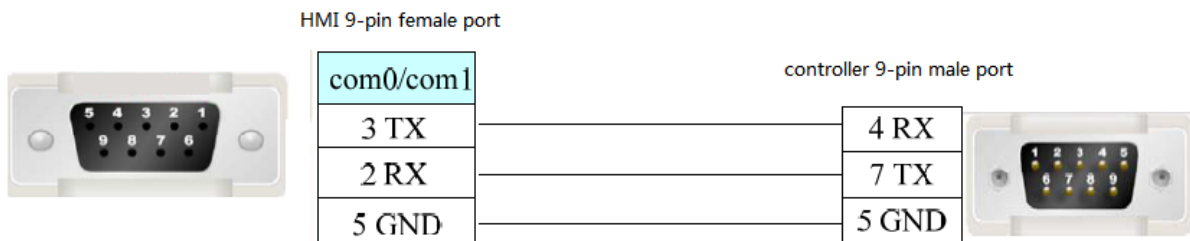

Fig 1

(b) Master K-cnet protocol RS485-2:

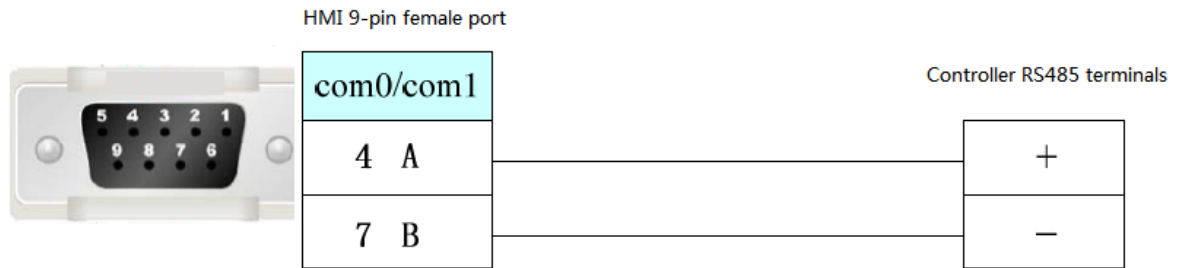

Fig 2

2.14.4 Device address

LGMaster-K80/120 (Cnet) series PLC

PLC address	Range	Data type	Explanation
M	0~9999F	Bit	Internal auxiliary relay
L	0~9999F	Bit	Link relay
K	0~9999F	Bit	Holding relay
T	0~9999	Bit	Timer
C	0~9999	Bit	Counter
P	0~9999F	Bit	I/O coil
D	0~9999	Word/DWord	Data register
TD	0~9999	Word/DWord	Current value of timer
CD	0~9999	Word/DWord	Current value of counter
S	0~9999	Word/DWord	Used as register
K	0~9999	Word/DWord	Used as register
M	0~9999	Word/DWord	Used as register
L	0~9999	Word/DWord	Used as register
F	0~9999	Word/DWord	Used as register
P	0~9999	Word/DWord	Used as register

2.15 LG Glofa(Cnet) series PLC

2.15.1 Device model

Series	CPU	Connected module	Port	Cable	Device
Glofa	G7M-DR20A	CPU RS232	RS232	Fig 1	LG Glofa (Cnet) series

Note: please turn on DIP switch2 and turn off switch1 for LG Glofa -cnet communication.

2.15.2 Parameters

HMI:

Parameters	Recommend settings	Choices of settings	Note
PLC type	LG Glofa (cnet)		
Port	RS232	RS232	
Data bit	8	7 or 8	
Stop bit	1	1 or 2	
Parity	No parity	Even/odd/no parity	
Baud rate	19200	4800/38400/9600/115200/19200/187500	
Station no.	0	0~255	

The default parameters of LG Glofa –Cnet: 19200, 8, 1, no parity, station no.0

PLC:

Note:

- 1. Turn on the switch BUILT-IN CNET on the PLC.**
- 2. “Dedicated-slave” must be choosed in the PLC programming software.**
- 3. The communication area of M must be set in the PLC programming software.**

M area size:

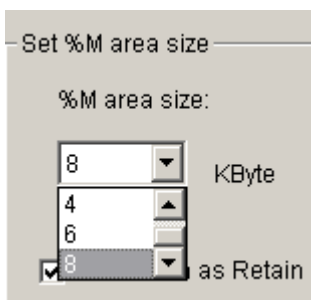

Protocol and mode settings:

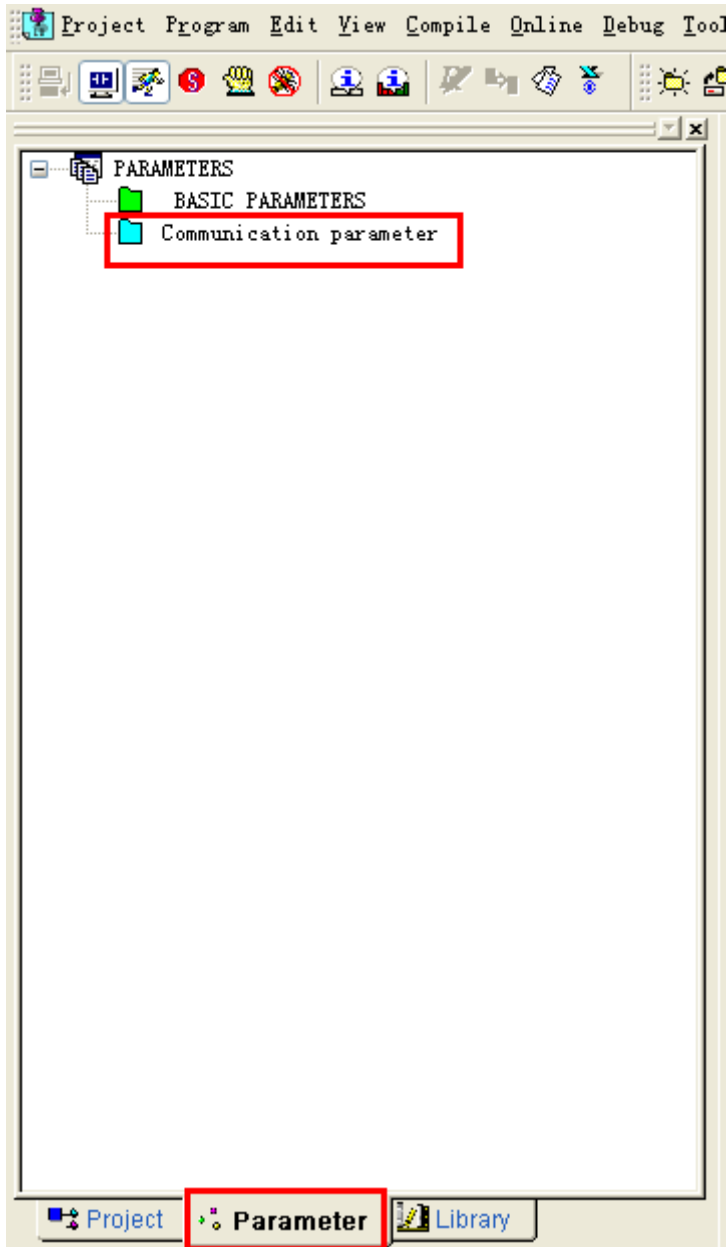

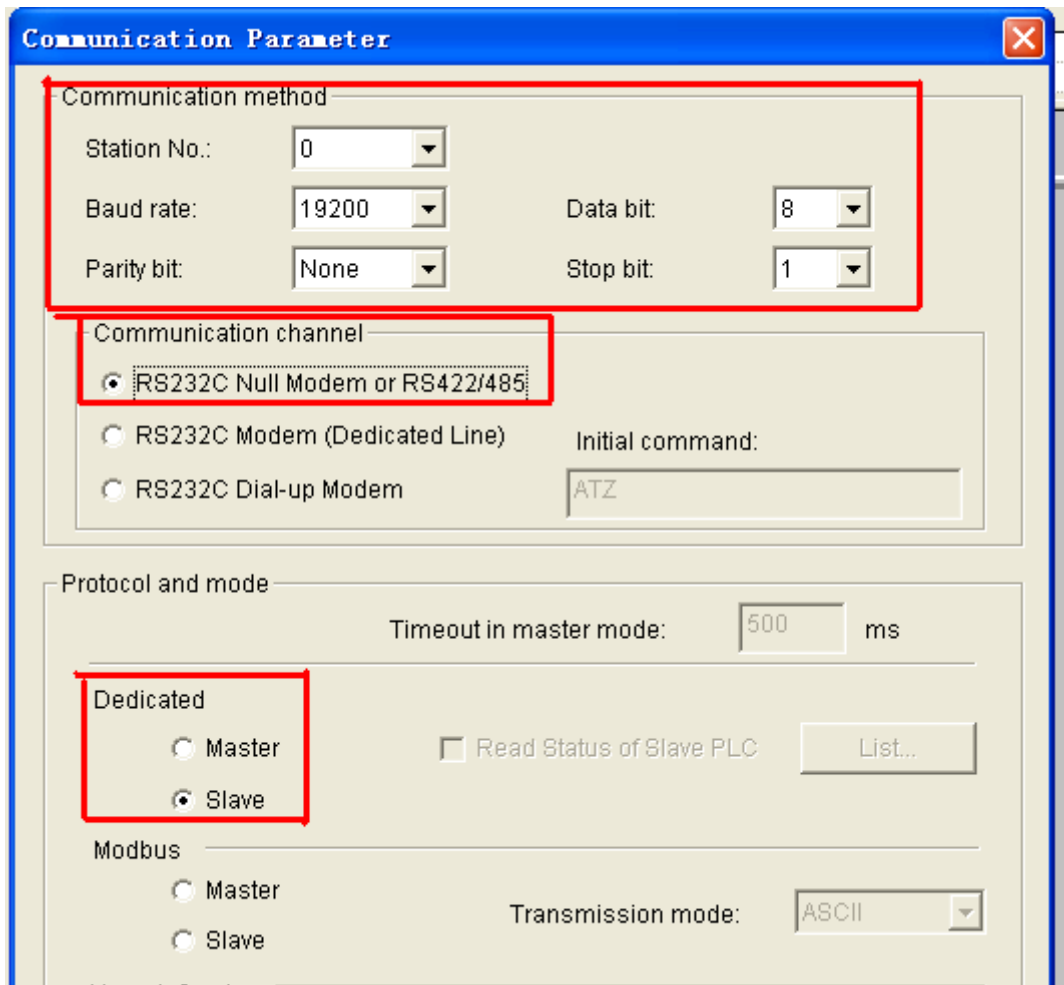

2.15.3 Cable making

LG Glofa –Cnet RS232:

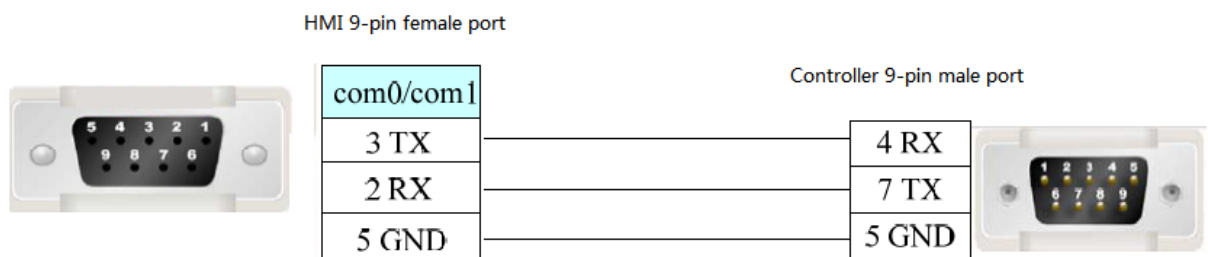

Fig 1

2.15.4 Device address

PLC type	Range	Data type	Explanation
M	0~16383	Bit	Internal auxiliary relay
IX	0.0.0~0.0.11	Bit	External input coil
	0.0.12~0.0.63	Bit	Internal auxiliary input coil
	0.1.0~0.1.63	Bit	Internal auxiliary input coil
	0.2.0~0.2.63	Bit	Internal auxiliary input coil
	0.3.0~0.3.63	Bit	Internal auxiliary input coil
	0.4.0~0.4.63	Bit	Internal auxiliary input coil
	0.5.0~0.5.63	Bit	Internal auxiliary input coil
	0.6.0~0.6.63	Bit	Internal auxiliary input coil
	0.7.0~0.7.63	Bit	Internal auxiliary input coil
QX	0.0.0~0.0.11	Bit	External output coil
	0.0.12~0.0.63	Bit	Internal auxiliary output coil
	0.1.0~0.1.63	Bit	Internal auxiliary output coil
	0.2.0~0.2.63	Bit	Internal auxiliary output coil
	0.3.0~0.3.63	Bit	Internal auxiliary output coil
	0.4.0~0.4.63	Bit	Internal auxiliary output coil
	0.5.0~0.5.63	Bit	Internal auxiliary output coil
	0.6.0~0.6.63	Bit	Internal auxiliary output coil
	0.7.0~0.7.63	Bit	Internal auxiliary output coil
IW	0.0.0~0.0.3	Word/DWord	Data register
	0.1.0~0.1.3	Word/DWord	Data register
	0.2.0~0.2.3	Word/DWord	Data register
	0.3.0~0.3.3	Word/DWord	Data register
	0.4.0~0.4.3	Word/DWord	Data register
	0.5.0~0.5.3	Word/DWord	Data register
	0.6.0~0.6.3	Word/DWord	Data register
	0.7.0~0.7.3	Word/DWord	Data register
QW	0.0.0~0.0.3	Word/DWord	Data register
	0.1.0~0.1.3	Word/DWord	Data register
	0.2.0~0.2.3	Word/DWord	Data register
	0.3.0~0.3.3	Word/DWord	Data register
	0.4.0~0.4.3	Word/DWord	Data register
	0.5.0~0.5.3	Word/DWord	Data register
	0.6.0~0.6.3	Word/DWord	Data register
	0.7.0~0.7.3	Word/DWord	Data register
MW	0~4095	Word	Data register
	0~4095	Regs	Data register
MD	0~2047	DWord	Data register

	0~2038	Regs	Data register
--	--------	------	---------------

2.16 LG XGT(CPU Direct) series PLC

2.16.1 Device model

Series	CPU	Connected module	Port	Cable	Device
XGT		CPU RS232	RS232	Fig 1	LG XGT series (CPU Direct)

2.16.2 Parameters

HMI:

Parameter	Recommend settings	Choices of settings	Note
PLC type	LG XGT series (CPU Direct)		
Port	RS232	RS232	
Data bit	8	7 or 8	
Stop bit	1	1 or 2	
Parity	No parity	Even/odd/no parity	
Baud rate	115200	4800/38400/9600/115200/19200/187500	
Station no.	1	0~255	

The default parameters of LG XGT series PLC (CPU Direct) : 115200, 8, 1, no parity, station no.1

Note: XGT series (CPU Direct) only supports the baud rate 115200 and cannot modify the station no.

2.16.3 Cable making

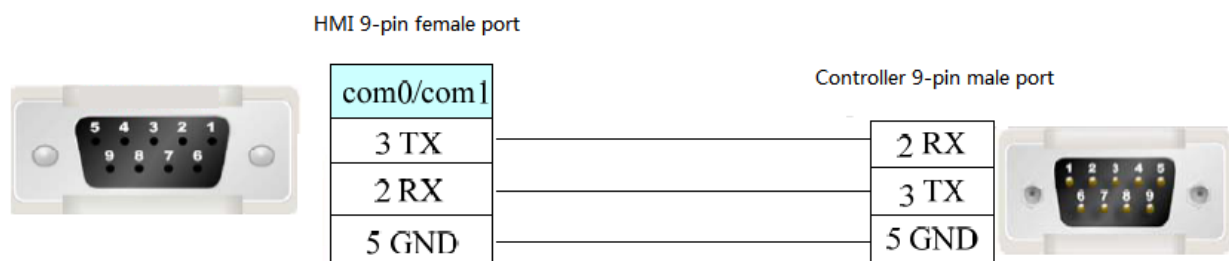

Fig1

2.16.4 Device address

PLC address	Range	Data type	Explanation
P	0.0~65535.F	Bit	External I/O coil
	65535	Word/DWord	Data register
M	0.0~65535.F	Bit	Internal auxiliary output coil
	65535	Word/DWord	Data register
L	0.0~65535.F	Bit	External output coil
	65535	Word/DWord	Data register
F	0.0~65535.F	Bit	Data register
	65535	Word/DWord	Data register
T	65535	Word/DWord	Data register
	65535	Bit	Counter
C	65535	Word/DWord	Data register
	65535	Bit	Counter
D	65535	Word/DWord	Data register
	0.0~65535.F	Bit	Relay
S	65535	Bit	Relay
K	65535	Word/DWord	Data register
	0.0~65535.F	Bit	Relay
Z	65535	Word/DWord	Data register
	0.0~65535.F	Bit	Relay
N	65535	Word/DWord	Data register
	0.0~65535.F	Bit	Relay
R	65535	Word/DWord	Data register
	0.0~65535.F	Bit	Relay
ZR	65535	Word/DWord	Data register
	0.0~65535.F	Bit	Relay
TS	65535	Word	Data register
CS	65535	DWord	Data register

2.17 Matsushita MEWNET FP series PLC

2.17.1 Device model

Matsushita- Mewnet FP series PLC include FP0, FP1, FP3, FP2SE, FP10SH and so on. They can communicate with Xinje HMI via the programming port or communication port on the CPU.

FP0-CXXCXX only supports RS232 connection.

Series	CPU	Connected module	Port	Cable	Device	
FP	FP0	Direct connect to the CPU	RS232	Fig 1	Matsushita FP0/FP1 series	
	FP-M	Direct connect to the CPU	RS232	Fig 1		
	FP-X	Direct connect to the CPU	RS232	Fig 1		
	FPΣ	Direct connect to the CPU	RS232	Fig 1		
	FP2	Direct connect to the CPU		RS232		Fig 1
			CPU RS232 com port	RS232		Fig 2
	FP2SH	Direct connect to the CPU		RS232		Fig 1
			CPU RS232 com port	RS232		Fig 2
	FP1	CPU RS232 com port		RS232		Fig 2
			CPU RS232 programming port	RS422		Fig 3
	FP3	CPU RS422 programming port	RS422	Fig 4		
FP10SH FP10S	CPU RS232 com port	RS232	Fig 2			
FP-E	Direct connect to the CPU	RS232	Fig 1			

2.17.2 Parameters

HMI:

Parameters	Recommend settings	Choices of settings	Note
PLC type	matsushita FP series PLC		
Port	RS232		
Data bit	8	7 or 8	
Stop bit	1	1 or 2	
Parity	Odd parity	Even/odd/no parity	
Baud rate	9600	4800/38400/9600/115200/19200/187500	
Station no.	1	0~255	

The default parameters of Matsushita FP series PLC: 9600, 8, 1, odd parity, station no.1

PLC:

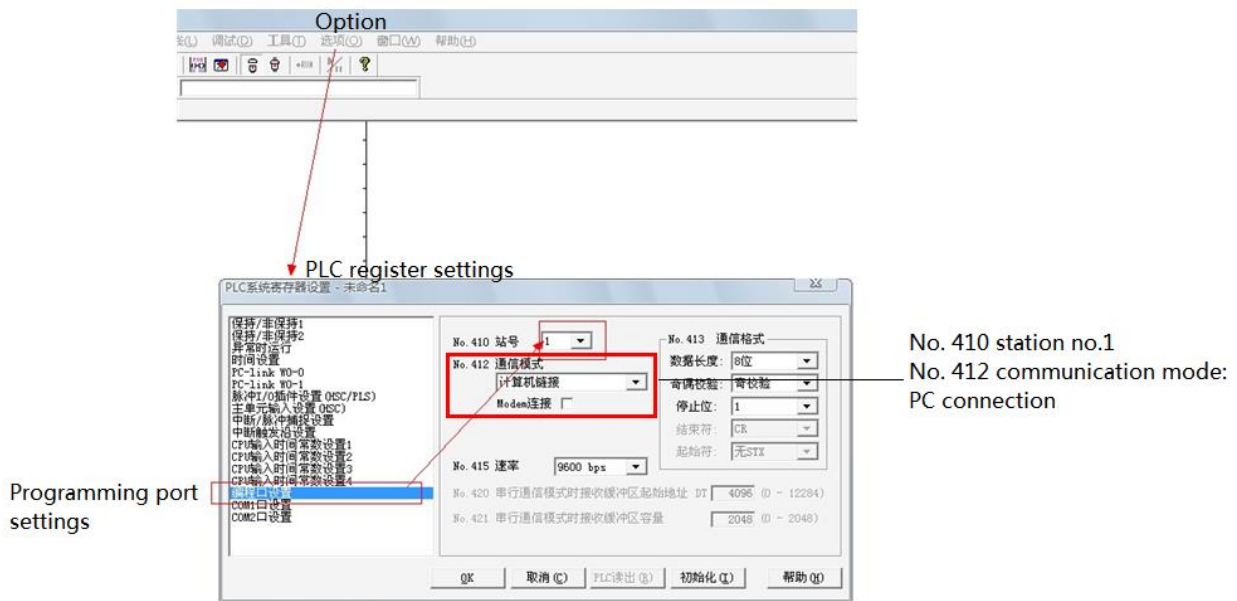

Note:

1. PLC soft component input example:

LC	HMI
R45	
Y1	

2. When making the PLC program, set the switch to PPOG; set the switch to RUN when communicating.
3. Do not choose <Common communication mode>, otherwise, the communication will be error.
4. FP series PLC default station no. is 1, please note FP3 series PLC station no. must set to 0.

2.17.3 Cable making

(a) CPU 5-pin DIN port:

Tool port:



HMI 9-pin port

com0/com1
3 TX
2 RX
5 GND

Controller 5-pin Mini Din

3 RXD
2 TXD
1 GND



Fig1

(b) CPU 9-pin port:



HMI 9-pin port

com0/com1
3 TX
2 RX
5 GND

Controller CPU RS232
9-pin male port

3 RXD
2 TXD
7 GND
4 RTS
5 CTS
8 CD
9 ER



Fig2

(c) CPU 8-pin port:

HMI 9-pin port

1	TD+
6	TD-
5	GND
8	RDD-
9	RDD+

Matsushita Mewnet-FP series
FP1 CPU RS422 8-pin port

6	RXD+
3	RXD-
1	GND
2	TXD-
5	TXD+

Fig3

(d) CPU 15-pin port:

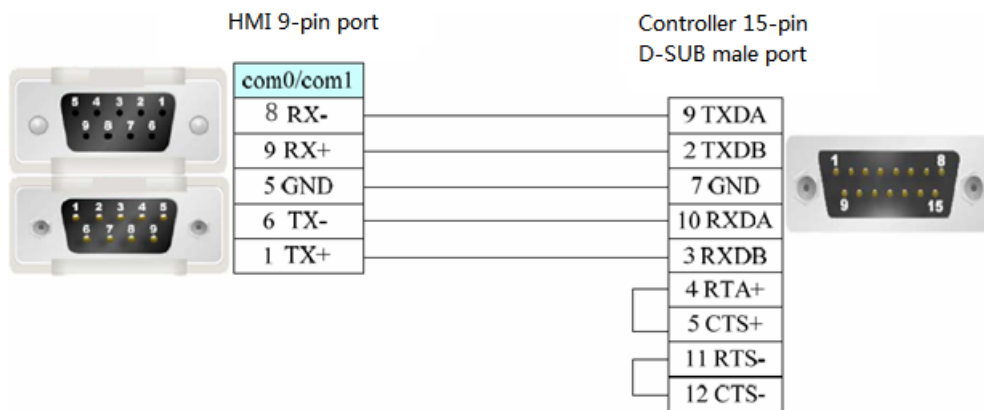

Fig4

2.17.4 Device address

PLC address	Range	Data type	Explanation
X	0~12 (0~F)	Bit	External input coil (bit)
WX	0~12	Word/DWord	Single/double words register
Y	0~12 (0~F)	Bit	External output coil (bit)
WY	0~12	Word/DWord	Single/double words register
R	0~62, 90~903	Bit	Internal auxiliary coil (bit)
WR	0~65535	Word/DWord	Single/double words register
T	0~99	Bit	Timer
L	65535F	Bit	Link coil
C	100~143	Bit	Counter
SV	0~143	Word/DWord	Setting register
EV	0~143	Word/DWord	Real value of counter or timer
DT	0~65535	Word/DWord	Single/double words data register

2.18 Schneider PLC

2.18.1 Device model

Series	CPU	Connected module	Port	Cable	Device
Micro	TSX 37-05 TSX 37-08 TSX 37-10 TSX 37-21/22	Direct connect to CPU	RS485	Fig 1	Schneider Micro/ NEZA/Twido Series PLC
Twido	Twido series CPU	Direct connect to CPU	RS485	Fig 1	
M	M218 M238 M258	Direct connect to CPU	RS485	Fig 2	
NEZA	TSX07 series CPU	Direct connect to CPU	RS485	Fig 1	

2.18.2 Parameters

HMI:

Parameters	Recommend settings	Choices of settings	Note
PLC type	Schneider Micro/NEZA /Twido series PLC		
Port	RS485		
Data bit	8	7 or 8	
Stop bit	1	1 or 2	
Parity	Even parity	Even/odd/no parity	
Baud rate	19200	4800/38400/9600/115200/19200/187500	
Station no.	1	0~255	

The default parameters of Schneider Micro/NEZA/ Twido series PLC: 19200, 8, 1, even parity, station no.1

PLC:

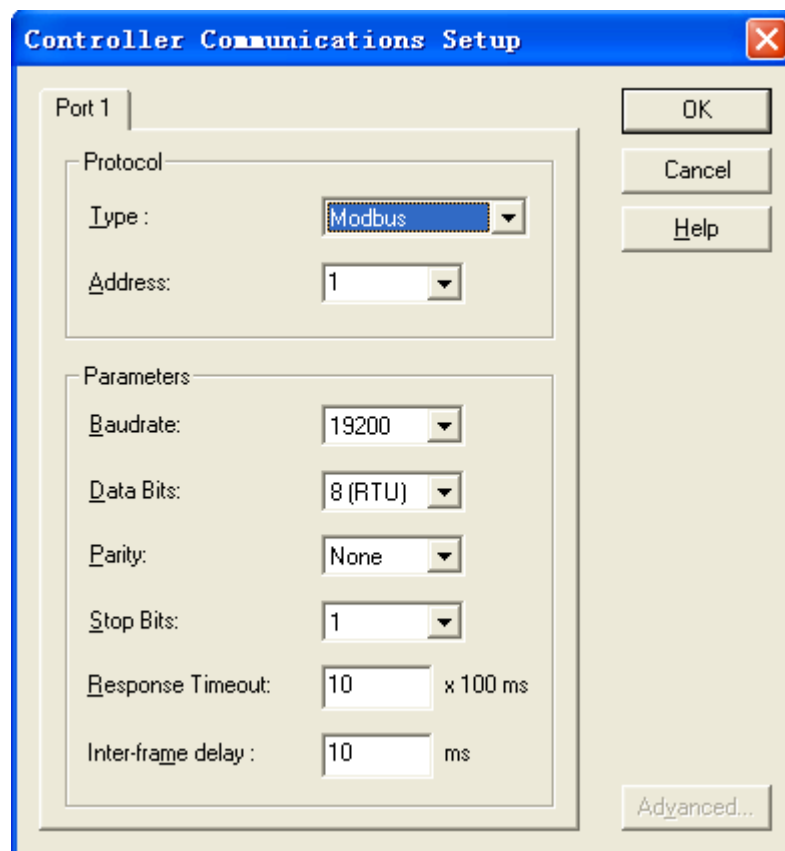
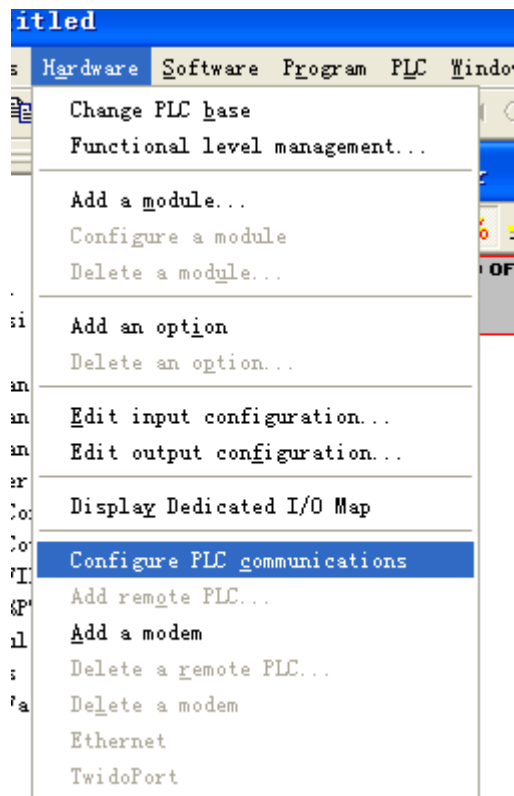

Note:

The object address of Twido PLC is dynamic and can be enlarged in the PLC programming software. Please release the max coil address in the program. For example: the max coil address is M127, please output M127 in the program.

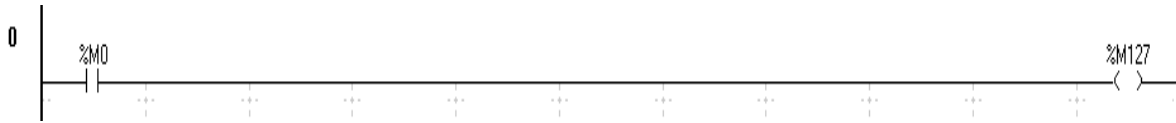

2.18.3 Cable making

(a) Direct connect to CPU:

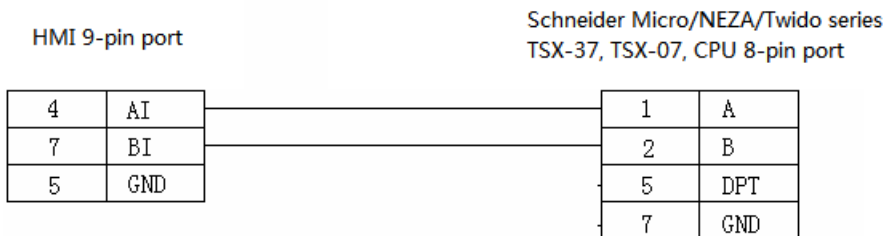

Fig1

(b) M238 RJ-45 RS485:

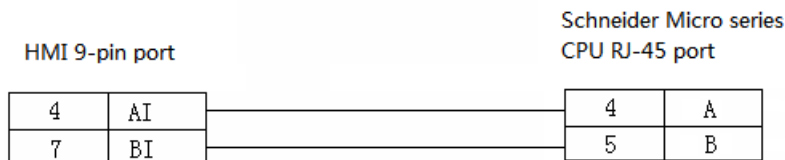

Fig2

2.18.4 Device address

PLC address	Range	Data type	Explanation
M	0~2047	Bit	Internal coil
MW	0.00~65535.15	Bit	Internal coil
MW	0~2047	Word/DWord	Register

2.19 Fatek FB series PLC

2.19.1 Device model

Series	CPU	Connected module	Port	Cable	Device
FBs	FBs -20MN	Direct connect to CPU	RS232	Fig 1	Fatek MU /MA series
	FBs -32MN		RS485	Fig 2	
FB -MC	20MC		RS232	Fig 1	
	28MC		RS485	Fig 2	
	40MC				
	19MCT				
26MCT					
36MCT					
FB -MA	20MA	FB-DTBR/DTBR-E module	RS232	Fig 3	
	28MA		RS232	Fig 4	
	40MA		RS485	Fig 5	

Note: MA series PLC needs to configure FB-DTBR or FB-DTBR-E module, uses RS232 or RS485 connection.

2.19.2 Parameters

HMI:

Parameters	Recommend settings	Choices of settings	Note
PLC type	Fatek MC/MA/MU series PLC		
Port	RS232	RS232 or RS485	
Data bit	7	7 or 8	
Stop bit	1	1 or 2	
Parity	Even parity	Even/odd/no parity	
Baud rate	9600	4800/38400/9600/115200 /19200/187500	
Station no.	1	0~255	

The default parameters of Fatek MC/MA/MU series PLC: 9600, 7, 1, even parity, station no.1

2.19.3 Cable making

(a) FBs Port0 RS232:

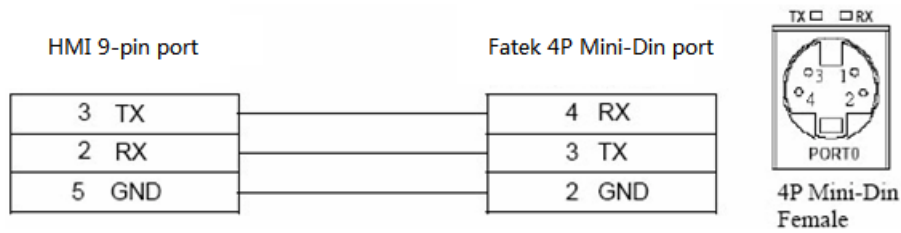

CPU port:

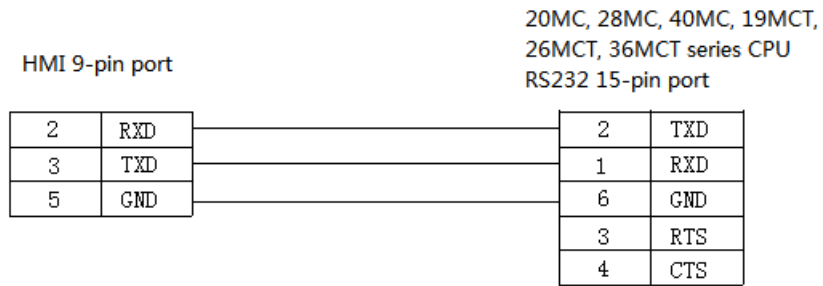

Fig1

(b) CPU RS485:

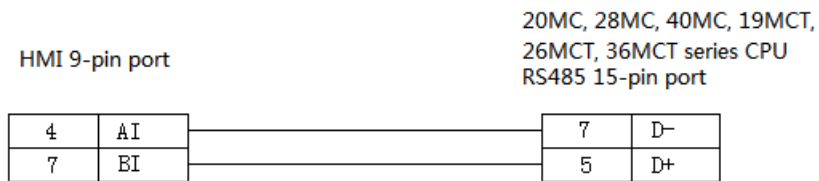

Fig2

(c) FB-DTBR/DTBR-E module RS232:

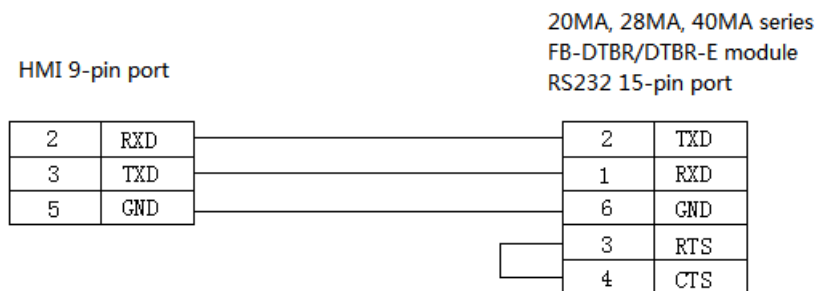

Fig3

(d) FB-DTBR/DTBR-E module RS232:

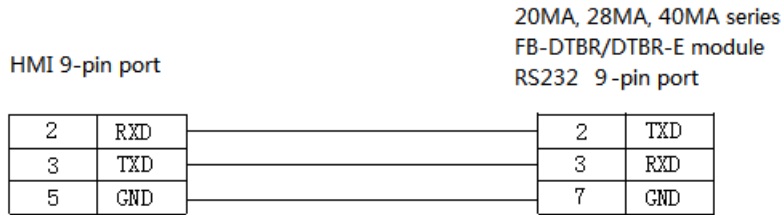

Fig4

(e) FB-DTBR/DTBR-E module RS485:

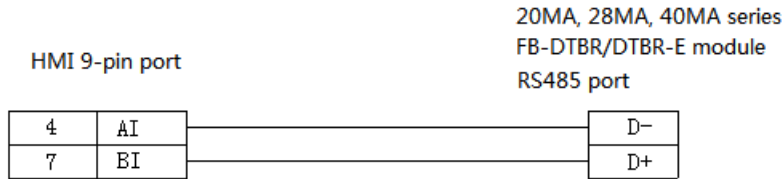

Fig5

2.19.4 Device address

FATEK-FB series PLC

PLC address	Range	Data type	Explanation
M	0~2001	Bit	Internal auxiliary coil
X	0~255	Bit	External input coil
Y	0~255	Bit	External output coil
S	0~999	Bit	Sequence control coil
T	0~255	Bit	Timer
C	0~255	Bit	Counter
R	0~9000	Word/Dword	Register
X	0~255	Word/Dword	Used as register
Y	0~255	Word/Dword	Used as register
M	0~2001	Word/Dword	Used as register
S	0~999	Word/Dword	Used as register
D	0~3071	Word/Dword	Used as register
TD	0~255	Word/Dword	Used as register
C16	0~199	Word/Dword	16-bit counter
C32	200~255	Word/Dword	32-bit counter
T	0~255	Word/Dword	Timer state

2.20 Vigor VIGOR PLC

2.20.1 Device model

Series	CPU	Connected module	Port	Cable	Device
VB	VB0-14M	Direct connect to the CPU	RS232	Fig 1	Vigor VB Series PLC
	VB0-20M				
	VB0-28M	Connect to the extension card	RS232	Fig 2	
	VB0-32M				
	VB1-14MT-D				
	VB1-24MT-D				
	VB1-32MTMT-D				
	VB2-16M				
VB2-32M	RS422	Fig 3			
		RS485	Fig 4		
VH	VH -14MR	Direct connect to the CPU	RS232	Fig 1	

2.20.2 Parameters

HMI:

Parameters	Recommend settings	Choices of settings	Note
PLC type	Vigor VB series PLC		
Port	RS232	RS232/RS485/RS422	
Data bit	7	7 or 8	
Stop bit	1	1 or 2	
Parity	Even parity	Even/odd/no parity	
Baud rate	19200	4800/38400/9600/115200/19200/187500	
Station no.	0	0~255	

The default parameters of Vigor VB series PLC: 19200, 7, 1, even parity, station no.0

2.20.3 Cable making

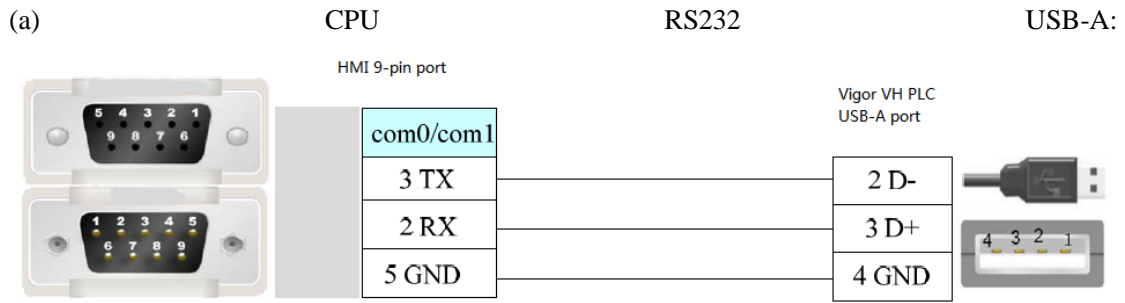

Fig1

(b) CPU direct connection or RS232 extension card:

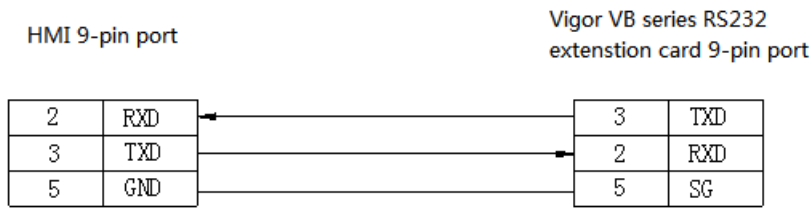

Fig2

(c) CPU direct connection or RS485 extension card:

1. RS422 connection

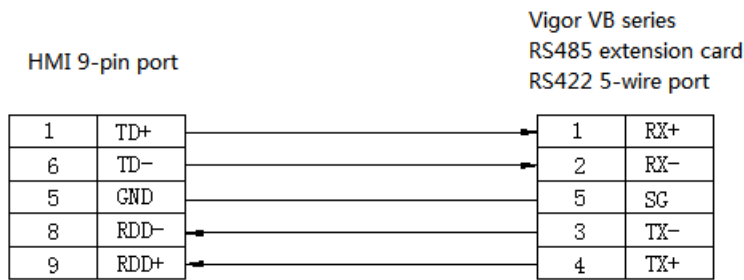
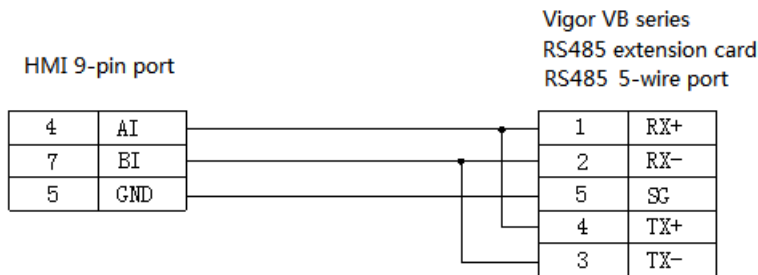

Fig3

2. RS485 connection



Fi4

2.20.4 Device address

PLC address	Range	Data type	Explanation
X	0~777	Bit	External input coil
Y	0~777	Bit	External output coil
M	0~9255	Bit	Internal auxiliary coil
S	0~999	Bit	Special auxiliary coil
TSTATUS	0~255	Bit	Status of timer
CSTATUS	0~255	Bit	Status of counter
TCOIL	0~255	Bit	Timer coil
CCOIL	0~255	Bit	Counter coil
C16	0~199	Word	16-bit counter
C32	200~255	DWord	32-bit counter
D	0~9255	Word/ DWord	Data register
TW	0~255	Word/ DWord	Current timer value
X	0~777	Word/ DWord	Used as register
Y	0~777	Word/ DWord	Used as register
M	0~9255	Word/ DWord	Used as register
S	0~999	Word/ DWord	Used as register

2.21 Fuji SPB series PLC

2.21.1 Device model

Fuji MICREX-SX SPB series PLC

Series	CPU	Connected module	Port	Cable	Device
SPB	NW0P20	Communication adapter NW0LA-RS2	RS232	Fig 1	Fuji SPB series PLC
	NW0P30			Fig 3	
	NW0P40	Communication adapter NW0LA-RS4	RS485	Fig 2	
				Fig 3	

2.21.2 Parameters

HMI:

Parameter	Recommend settings	Choices of settings	Note
PLC type	Fuji SPB series PLC		
Port	RS232	RS232/RS485	
Data bit	8	7 / 8	
Stop bit	1	1 / 2	
Parity	Odd parity	Even/odd/no parity	
Baud rate	19200	4800/38400/9600/115200/19200/187500	
Station no.	0	0~255	

2.21.3 Cable making

(a) NW0LA-RS2 module RS232:

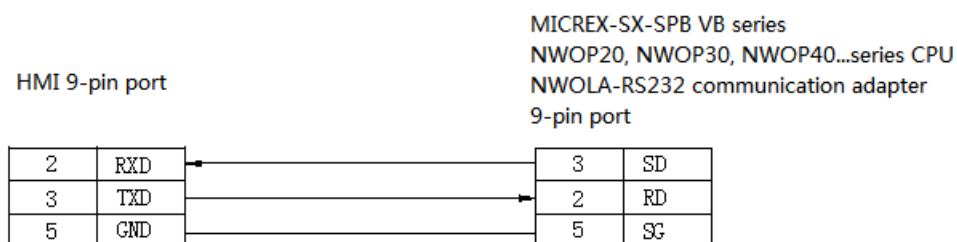

Fig1

(b) NW0LA-RS4 module RS485:

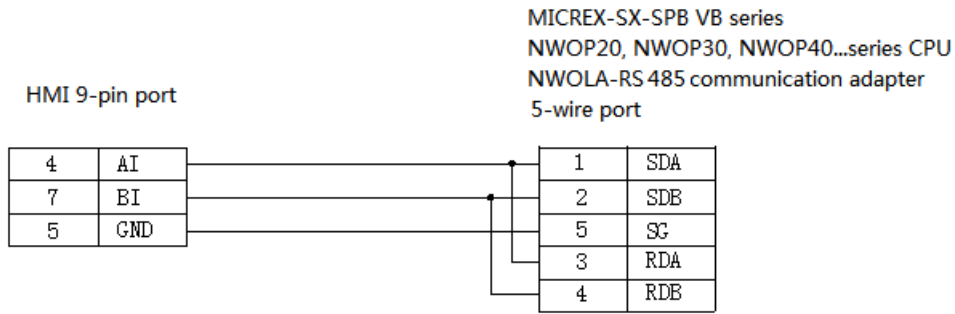

Fig2

(c) RJ-45 RS422:

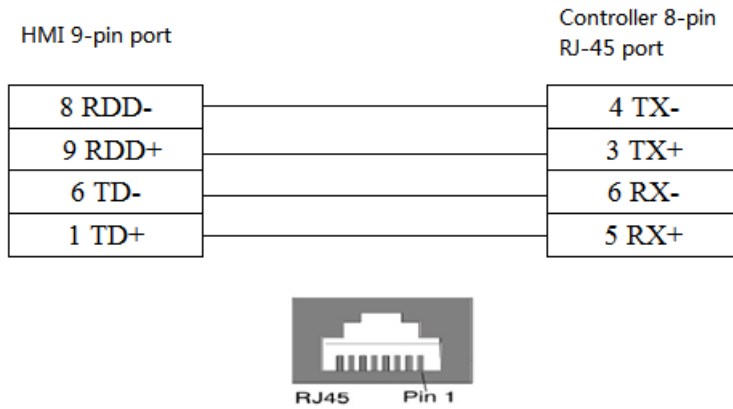

Fig3

2.21.4 Device address

PLC address	Range	Data type	Explanation
X	0~15	Bit	External input coil
Y	0~15	Bit	External output coil
M	0~15	Bit	Internal auxiliary coil
L	0~15	Bit	Special auxiliary coil
T	0~511	Bit	Timer
C	0~255	Bit	Counter
SM	0~15	Bit	Special auxiliary coil
WX	0~63	Word/DWord	Used as register
WY	0~63	Word/DWord	Used as register
WM	0~63	Word/DWord	Used as register
WL	0~255	Word/DWord	Used as register
WSM	32768~33023	Word/DWord	Used as register

D	0~8191	Word/DWord	Data register
TW	0~511	Word/DWord	Used as register
CW	0~255	Word/DWord	Used as register
LD	0~10000	Word/DWord	Used as register
SD	32768~33023	Word/DWord	Used as register

2.22 Keyence KV series PLC

2.22.1 Device model

CPU	Connected module	Port	Cable	Device
KV-10DR KV-24 KV-16 KV-40	Direct connect to the CPU	RS232	Fig 1	Keyence KV series
KZ-300	Serial port module KZ-L2	RS232	Fig 2, fig 3	
		RS422	Fig 4	
KV-700	Serial port module KZ-L20	RS232	Fig 5, fig 6	
		RS422	Fig 7	

2.22.2 Parameters

HMI:

Parameters	Recommend settings	Choices of settings	Note
PLC type	keyence KV series		
Port	RS232 port	RS232/RS422	
Data bit	8	7 or 8	
Stop bit	1	1 or 2	
Parity	Even parity	Even/odd/no parity	
Baud rate	9600	4800/38400/9600/115200/19200/187500	
Station no.	1	0~255	

The default parameters of Keyence KV series PLC: 9600, 8, 1, even parity, station no.1

2.22.3 Cable making

(a) CPU RS232 RJ-11:

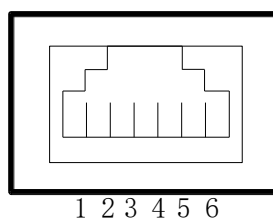

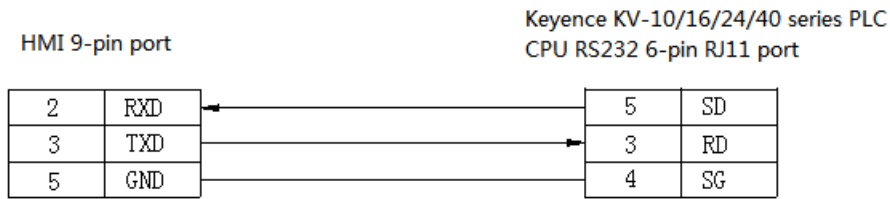

Fig1

(b) Serial port module KZ-L2 (Port1, RS232) connects to Keyence KZ-300 PLC:

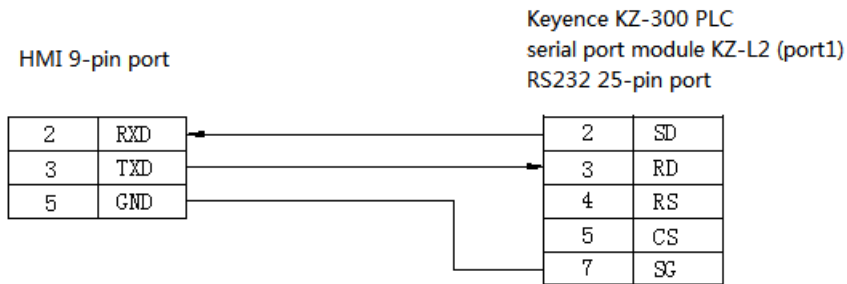

Fig2

(c) Serial port module KZ-L2 (Port2, RS232) connects to Keyence KZ-300 PLC:

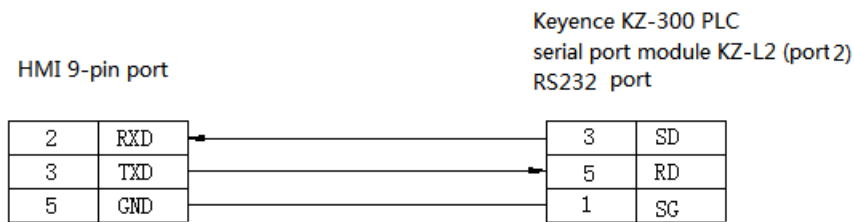

Fig3

(d) Serial port module KZ-L2 (Port2, RS422) connects to Keyence KZ-300 PLC:

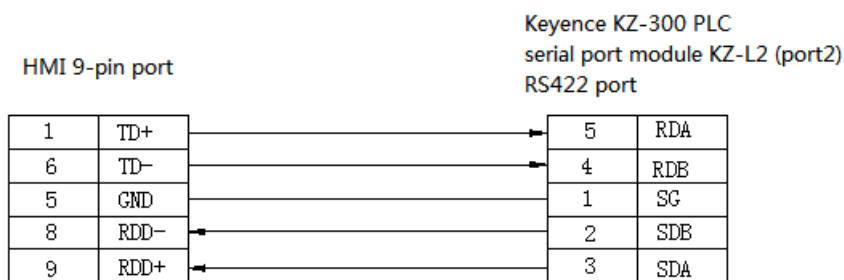

Fig4

(e) Serial port module KV-L20 (Port1, RS232) connects to Keyence KV-700 PLC:

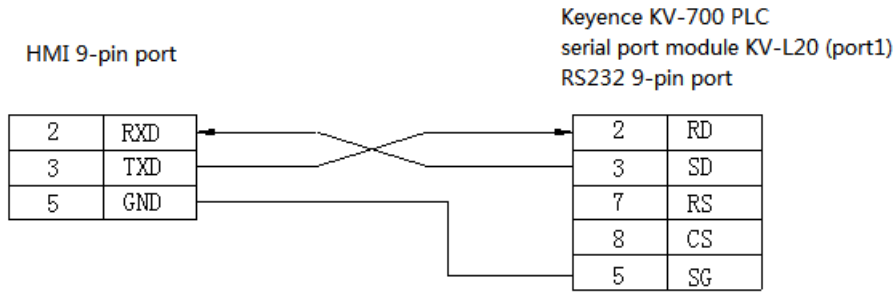

Fig5

(f) Serial port module KV-L20 (Port2, RS232) connects to Keyence KV-700 PLC:

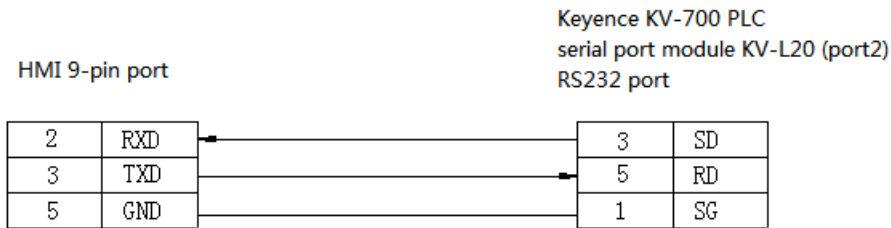

Fig6

(g) Serial port module KV-L20 (Port2, RS422) connects to Keyence KV-700 PLC:

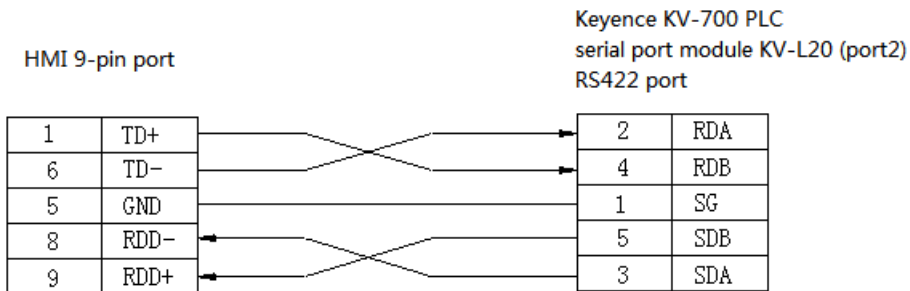

Fig7

2.22.4 Device address

PLC address	Range	Data type	Explanation
R	0~999	Bit	Coil
DM	0~8000	word	Data register

2.23 Emerson EC20 series PLC

2.23.1 Device model

Series	CPU	Connected module	Port	Cable	Device
EC20	EC20	COM0 port	RS232	Fig 1	Emerson EC20 Series PLC
		COM1 port	RS485	Fig 2	
			RS232	Fig 3	

2.23.2 Parameters

HMI:

Parameters	recommend settings	Choices of settings	Note
PLC type	Emerson EC20 series PLC		
Port	RS232	RS232/RS485	
Data bit	8	7 or 8	
Stop bit	1	1 or 2	
Parity	Even parity	Even/odd/no parity	
Baud rate	19200	4800/38400/9600/115200 /19200/187500	
Station no.	1	0~255	

The default parameters of Emerson EC20 series PLC: 19200, 8, 1, even parity, station no.1

2.23.3 Cable making

(a) Emerson EC20 PLC COM0 (RS232):

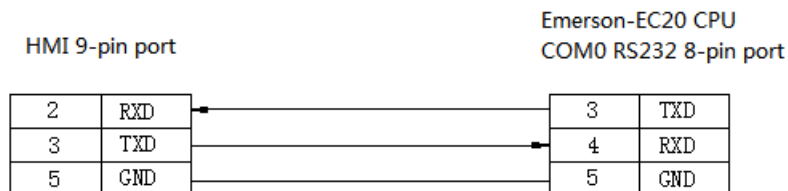

Fig1

(b) Emerson EC20 PLC COM1 (RS232):

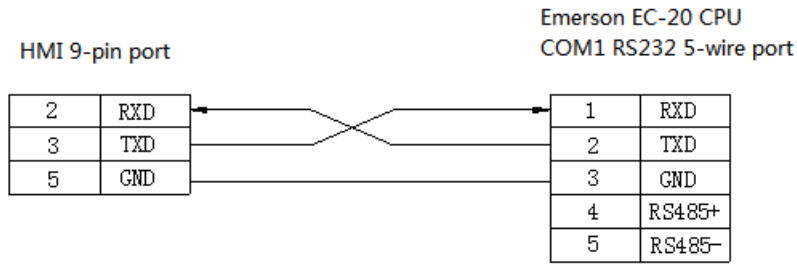

Fig2

(c) Emerson EC20 PLC COM1 (RS485):

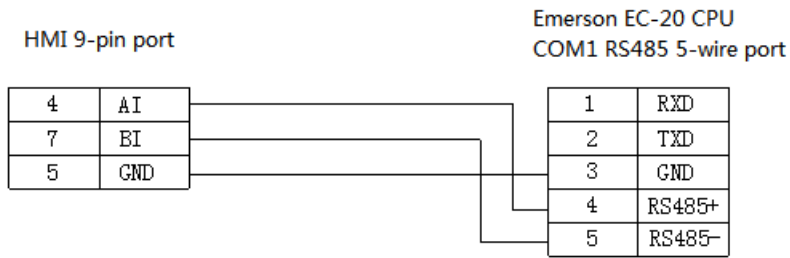

Fig3

Note: Emerson EC20 PLC COM1 supports RS232 and RS485.

2.23.4 Device address

PLC address	Range	Data type	Explanation
X	0~377	Bit	External input coil
Y	0~377	Bit	External output coil
M	0~2047	Bit	Internal auxiliary coil
S	0~1023	Bit	Special auxiliary coil
T	0~255	Bit	Timer
C	0~255	Bit	Counter
SM	0~9999	Bit	Special internal auxiliary coil
D	0~7999	Word/DWord	Data register
SD	0~255	Word/DWord	Used as register
Z	0~15	Word/DWord	Used as register
T	0~255	Word/DWord	Used as register
C16	0~199	Word/DWord	16-bit counter
C32	200~255	Word/DWord	32-bit counter

2.24 OEMax NX7 series PLC

2.24.1 Device model

Series	CPU	Connected module	Port	Cable	Device
NX7	NX7	COM0 port	RS232	Fig 1	OEMax NX7 Series PLC
			RS232	Fig 2	
		COM1 port	RS485	Fig 3	
			RS232	Fig 4	

2.24.2 Device address

HMI:

Parameter	Recommend settings	Choices of settings	Note
PLC type	OEMax NX70 series PLC		
Port	RS232	RS232/RS485	
Data bit	8	7 or 8	
Stop bit	1	1 or 2	
Parity	No parity	Even/odd/no parity	
Baud rate	9600	4800/38400/9600/115200 /19200/187500	
Station no.	1	0~255	

The default parameters of OEMax NX7 PLC: 9600, 8, 1, no parity, station no.1

2.24.3 Cable making

(a) OEMax NX7 PLC COM1 (RS232):

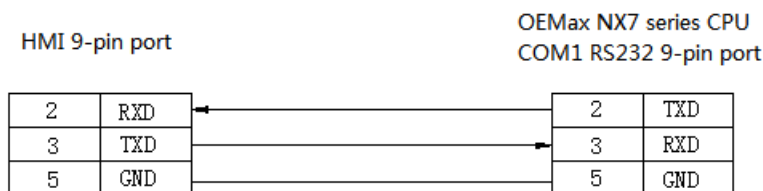

Fig1

(b) OEMax NX7 PLC COM1 (RS485):

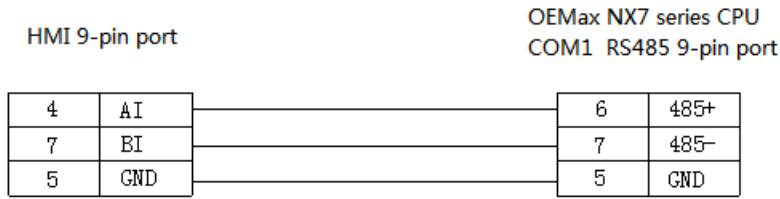

Fig2

(c) OEMMax NX7 PLC COM2 RJ-45 (RS232):

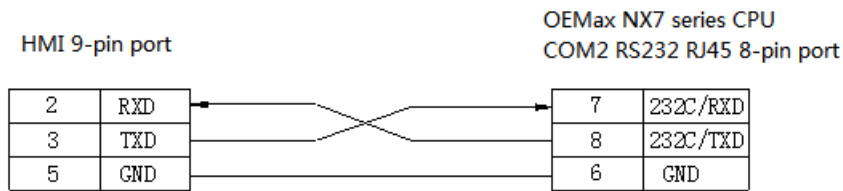
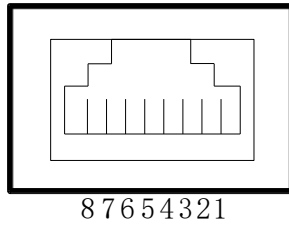

Fig3

(d) OEMMax NX7 PLC COM2 is RJ-45 8-pin port, short pin1 and 3 means RS485+; short pin2 and 4 means RS485- :

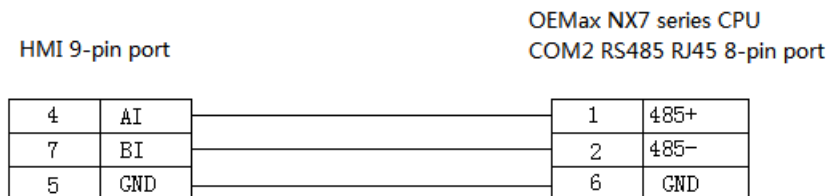

Fig4

OR

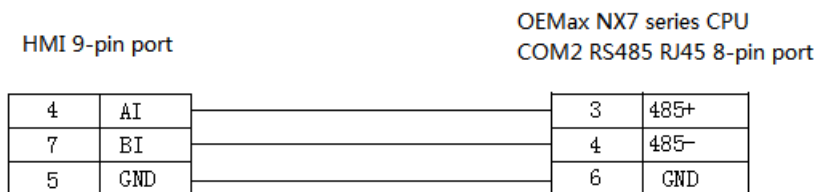

Fig5

2.24.4 Device address

PLC address	Range	Data type	Explanation
R	R000.00~R31.15	Bit	External I/O coil
	R32.00~R127.15	Bit	Special coil
L	L000.00~L063.15	Bit	Internal coil
M	M000.00~M127.15	Bit	Internal auxiliary coil
K	K000.00~K127.15	Bit	Internal holding coil
F	F000.00~F015.15	Bit	Special coil
TC	TC0~TC255	Bit	Timer /counter coil
W	0~6000	Word/DWord	Data register
R	0~127	Word/DWord	Used as register
L	0~63	Word/DWord	Used as register
M	0~127	Word/DWord	Used as register
K	0~127	Word/DWord	Used as register
F	0~15	Word/DWord	Used as register
SV	0~255	Word/DWord	Timer/counter settings
PV	0~255	Word/DWord	Timer/counter current value
SR	0~511	Word/DWord	Special register

2.25 Bosch Rexroth IndraControl L40 series PLC

2.25.1 Device model

Bosch Rexroth IndraControl L40 series PLC can communicate with Xinje HMI via COM0 and COM1.

CPU	Connected module	Port	Cable	Device
IndraControl L40	Direct connect to CPU	RS232	Fig 1	Bosch Rexroth IndraControlL40 Series PLC

2.25.2 Parameters

HMI:

Parameters	Recommend settings	Choices of settings	Note
PLC type	IndraControl L40 series PLC		
Port	RS232	RS232	
Data bit	8	7 or 8	
Stop bit	1	1 or 2	
Parity	Even parity	Even/odd/no parity	
Baud rate	9600	4800/38400/9600/115200 /19200/187500	
Station no.	1	0~255	

The default parameters of **IndraControl L40** series PLC: 9600, 8, 1, even parity, station no.1

2.25.3 Cable making

IndraControl L40 PLC RS232:

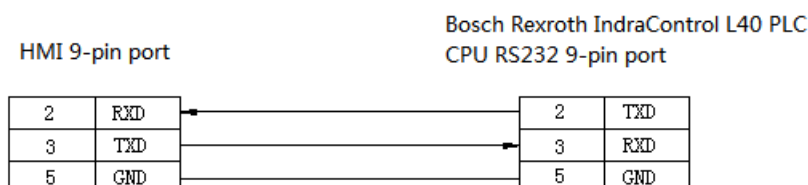

Fig1

2.25.4 Device address

IndraControl L40 series PLC

PLC address	Range	Data type	Explanation
X	0~9999	Bit	External I/O coil
B	0~9999	Byte	Used as register
W	0~9999	Word	Used as register
D	0~9999	DWord	Used as register
R	0~9999	DWord	Used as register
SB	0~9999	Byte	Used as register
SW	0~9999	Word	Used as register
SD	0~9999	DWord	Used as register

2.26 OPTO 22 SNAP series PLC

2.26.1 Device model

Series	CPU	Connected module	Port	Cable	Device
OPTO 22	SNAP	Direct connect to CPU	RS232	Fig 1, fig 2	OPTO 22 series
			RS485	Fig 3	

2.26.2 Parameters

HMI:

Parameters	Recommend settings	Choices of settings	Note
PLC type	OPTO 22 series PLC		
Port	RS232	RS232/RS485	
Data bit	8	7 or 8	
Stop bit	1	1 or 2	
Parity	No parity	Even/odd/no parity	
Baud rate	115200	4800/38400/9600/115200/19200/187500	
Station no.	1	0~255	

The default parameters of OPTO 22 series PLC: 115200, 8, 1, no parity, station no.1

2.26.3 Cable making

(a) RS232 connection:

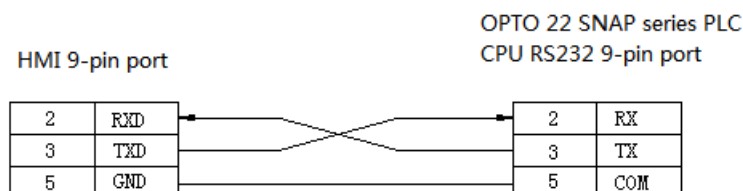

Fig1

(b) RS485 connection:

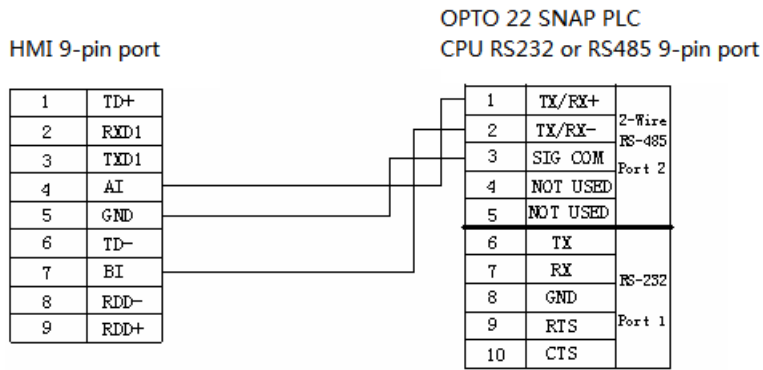

Fig2

(c) RS232 connection:

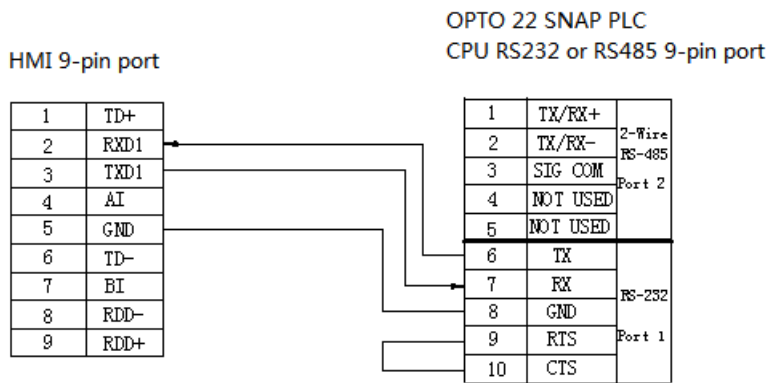

Fig3

2.26.4 Device address

PLC address	Range	Data type	Explanation
DI	0~9999	Bit	External input coil
DO	0~9999	Bit	External output coil
PID000~PID031	0~6	Bit	
I	0~9999	DWord	Used as register
F	0~9999	DWord	Used as register
AI	0~9999	DWord	Used as register
AO	0~9999	DWord	Used as register

2.27 SAIA-Burgess PCD series PLC

2.27.1 Device model

SAIA—Burgess PCD series PLC communicates with Xinje HMI via socket A or socket B port.

(a) Direct connect to CPU

CPU	Connected module	Port	Cable	Device
PCD1.M110 PCD1.M125 PCD1.M135	CPU PORT #0	RS232	Fig 1	SAIA—Burgess PCD series
PCD2.M120 PCD2.M150 PCD2.M170	CPU PORT #0	RS485	Fig 2	
PCD2.M480	CPU PORT #6			

(b) Through serial port

CPU	Connected module	Port	Cable	Device
PCD1.M125 PCD1.M135 PCD1.M110 PCD1.M120 PCD2.M480 PCD2.M170 PCD2.M150 Socket A	PCD7.F110	RS485	Fig 4	SAIA—Burgess PCD series
		RS422	Fig 5	
	PCD7.F120	RS232	Fig 3	
PCD2.M170	PCD2.F520 PCD7.F772/F802	RS232	Fig 6	
		RS485	Fig 7	
		RS422	Fig 10	
PCD2.M170	PCD2.F520/F530	RS232	Fig 6	
		RS485	Fig 7	
	PCD7.F772/F802	RS485	Fig 8	
PCD2.M480	PCD2.F520/F522	RS232	Fig 9 or fig 11	
		RS422	Fig 10	

2.27.2 Parameters

HMI:

Parameters	Recommend settings	Choices of settings	Note
PLC type	SAIA—Burgess PCD Series PLC		
Port	RS232	RS232/RS485	
Data bit	8	7 or 8	
Stop bit	1	1 or 2	
Parity	No parity	Even/odd/no parity	
Baud rate	19200	4800/38400/9600/115200/19200/187500	
Station no.	0	0~255	

SAIA—Burgess PCD series PLC: 19200, 8, 1, no parity, station no.0

2.27.3 Cable making

(a) Direct connect to PGU RS232:

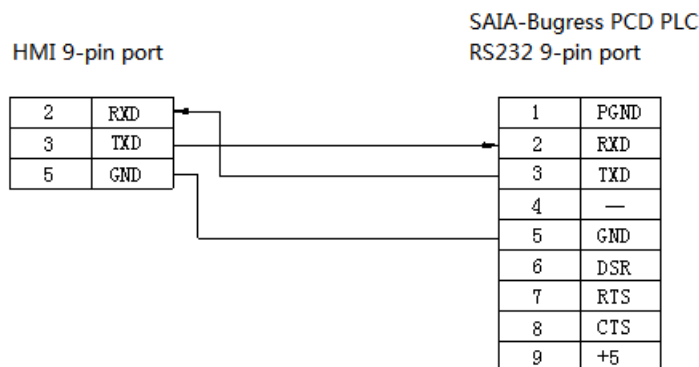

Fig1

(b) Direct PGU RS485:

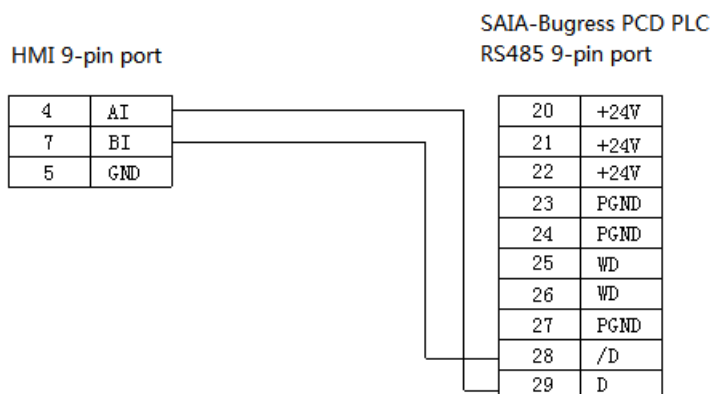

Fig2

(c) Socket A port (PCD7.F120):

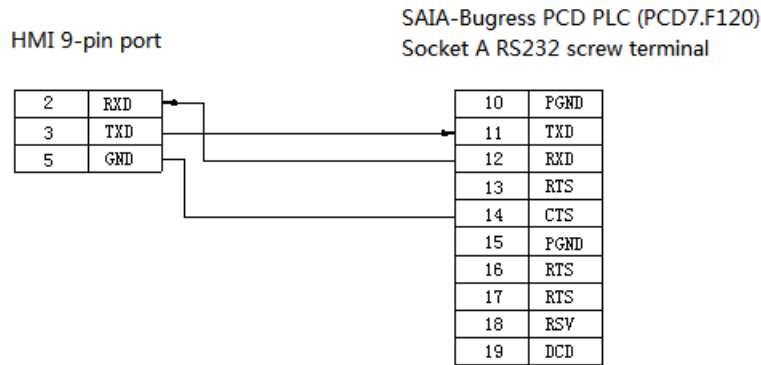

Fig3

(d) Through Socket A port (PCD7.F110):

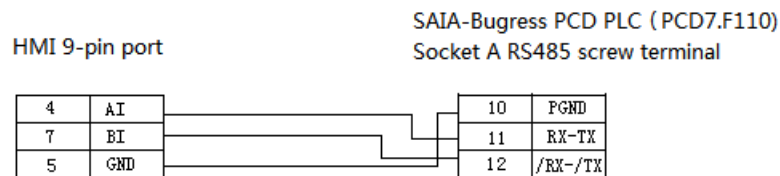

Fig4

(e) Socket A port (PCD7.F110):

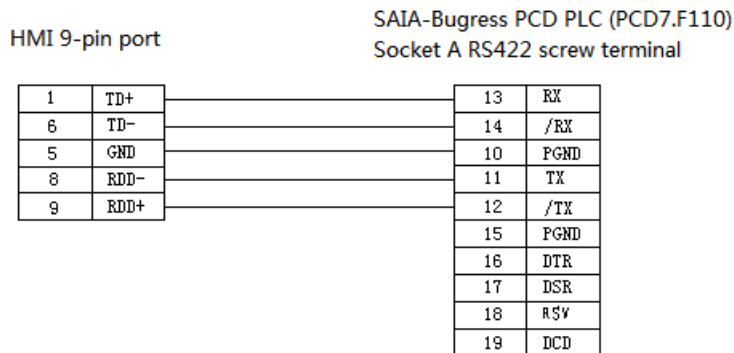

Fig5

(f) Socket B/B1 and B2 port (PCD2.F520/F530):

SAIA-Bugress PCD PLC (PCD2.F520/F530)
Socket B/B1 and B2 RS232 screw terminal

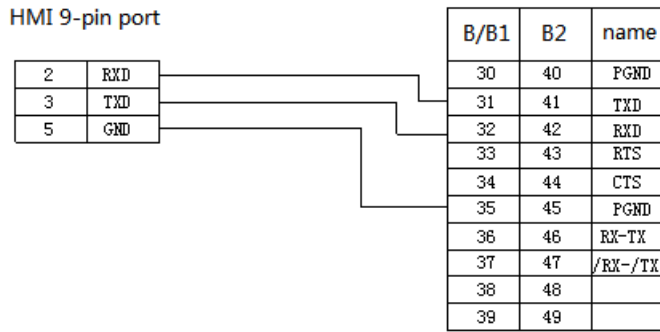

Fig6

(g) Socket B/B1 and B2 port (PCD2.F520/F530):

SAIA-Bugress PCD PLC (PCD2.F520/F530)
Socket B/B1 and B2 RS485 screw terminals

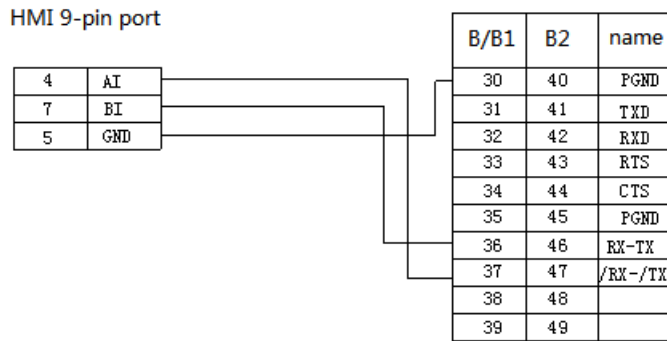

Fig7

(h) Socket B/B1&B2 port (PCD7.F772/F802):

SAIA-Bugress PCD PLC (PCD7.F772/F802)
Socket B/B1&B2 RS485 screw terminals

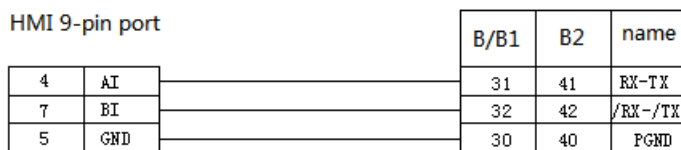

Fig8

(i) Socket B/B1&B2 port (PCD2.520/F530):

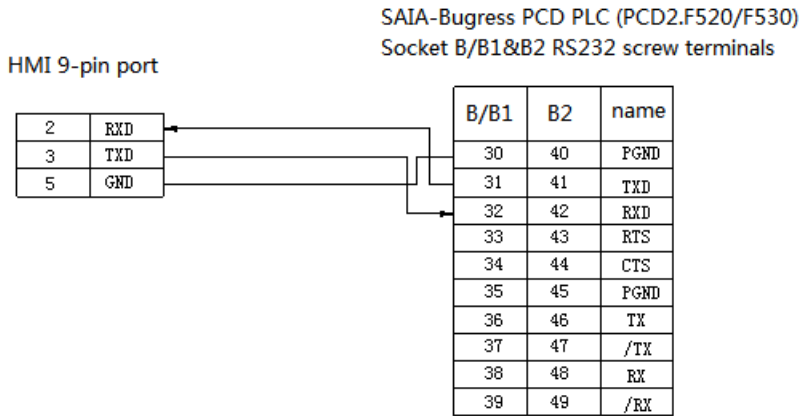

Fig9

(j) Socket B/B1&B2 port (PCD2.F520/F530):

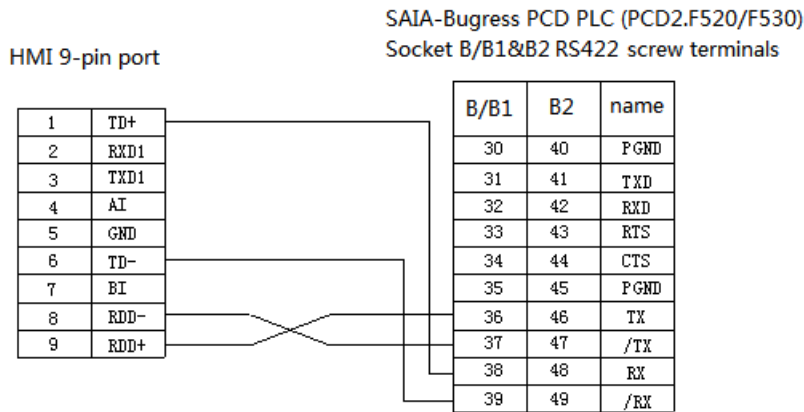

Fig10

(k) Socket B/B1&B2 port (PCD2.F520/F530):

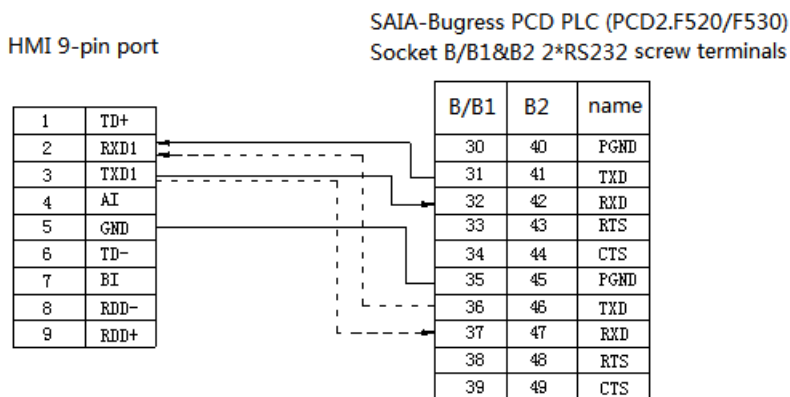

Fig11

2.27.4 Device address

PLC address	Range	Data type	Explanation
R	0~4095	DWord	Used as register
T	0~1599	DWord	Used as register
C	0~1599	DWord	Used as register
F	0~8000	Bit	Auxiliary coil
I	0~1023	Bit	External input coil
O	0~1023	Bit	External output coil

2.28 Allen-Bradley series PLC

2.28.1 Device model

Series	CPU	Connected module	Port	Cable	Device
Micrologix	Micrologix1000 Micrologix1200 Micrologix1500 (1762-L40BWA) (1764-LSP,1764-LRP)	CPU RS232	RS232	Fig 1	AB Mircrologix, SLC series (DF1 Full duplex protocol)
	Micrologix1400 (1766-L32BWAA)				
	Micrologix1500 (1764-LRP)				
SLC 500	SLC5/03 SLC5/04 SLC5/05	CPU RS232	RS232	Fig 2	
Mcicro830	2080-LC30	CPU RS232	RS232	Fig 1	Modbus RTU (panel is master)

2.28.2 Parameters

HMI:

Parameters	Recommend settings	Choices of settings	Note
PLC type	AB Mircrologix, SLC series (DF1	AB Mircrologix, SLC series (DF1 full-duplex)/Modbus	

	full-duplex)	RTU(panel is master)	
Port	RS232	RS232	
Data bit	8		
Stop bit	1		
Parity	No parity		
Baud rate	9600	9600/19200/38400	
Station no.	1	0~255	

The default parameters of AB Mircrologix SLC series (DF1 full-duplex): 9600, 8, 1, no parity, station no.0.

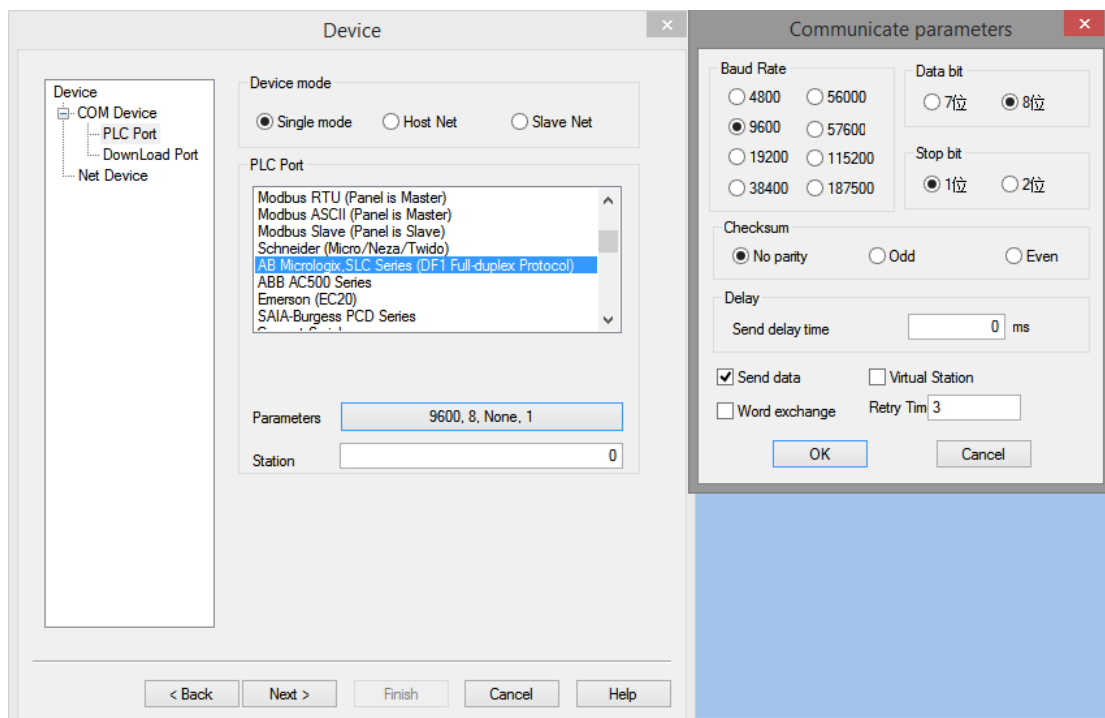

PLC setting:

Condition A: in touchwin software, the PLC protocol is AB Mircrologix, SLC series:

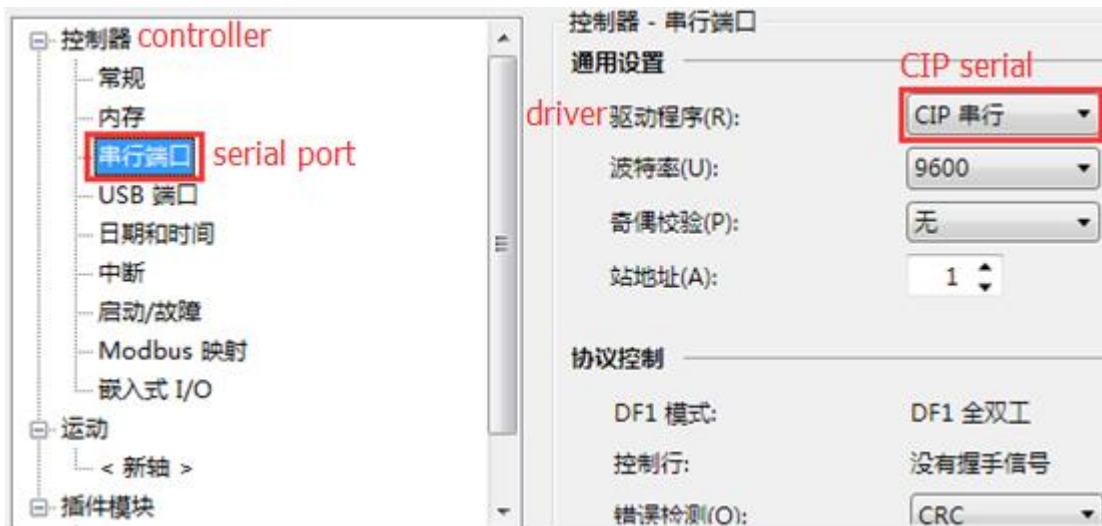

Condition B: in touchwin software, the PLC protocol is Modbus RTU (panel is master):



Note: for Modbus RTU communication, the address must set the mapping, PLC address 1 corresponds to Modbus address 0, PLC address 2 corresponds to Modbus address 1...

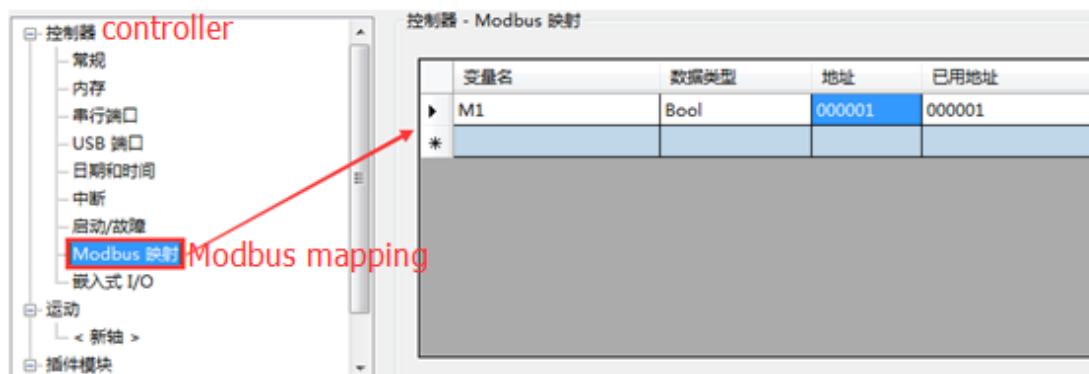

2.28.3 Cable making

(a) AB Micrologix series RS232:

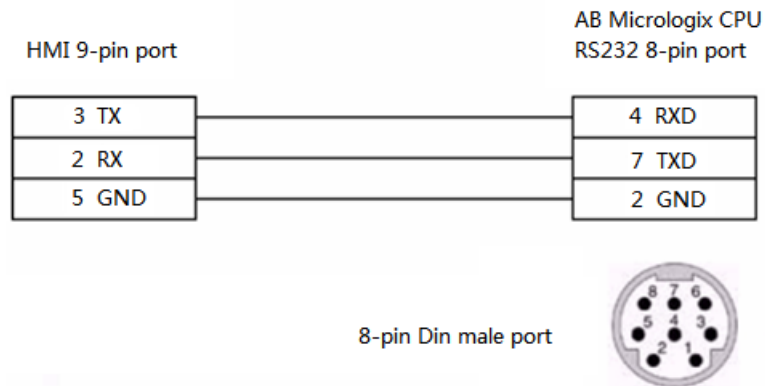

Fig1

(b) SLC500 RJ8 modular plug:

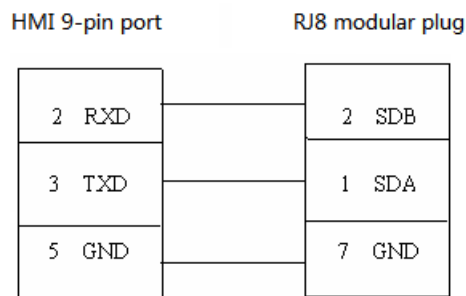

Fig2

2.28.4 Device address

Device address type	Range	Object type	Explanation
T4DN	0~999	Bit	Timer
C5DN	0~999	Bit	Counter
O	0.00~999.15	Bit	Output
I	0.00~999.15	Bit	Input
S	0.00~999.15	Bit	
B3	0.00~999.15	Bit	
R6	0.00~999.15	Bit	
N7	0.00~999.15	Bit	
O	0~999	Word	Used as register
I	0~999	Word	Used as register
S	0~999	Word	Used as register
B3	0~999	Word	Used as register
T4PRE	0~999	Word	Timer preset value
T4ACC	0~999	Word	Timer actual value

C5PRE	0~999	Word	Counter preset value
C5ACC	0~999	Word	Counter preset value
R6	0~999	Word	Data register
N7	0~999	Word/Dword	Data register
F8	0~999	Dword	Floating number register
R6LEN	0~999	Word	
P6POS	0~999	Word	

2.29 Xinje V5 series inverter

2.29.1 Device model

Series	Connected module	Port	Cable	Device
V5	CPU RS485 port	RS485	Fig 1	Thinget V5 series inverter

2.29.2 Parameters

HMI:

Parameters	Recommend settings	Choices of settings	Note
PLC type	Thinget V5 series inverter		
Port	RS485	RS485	
Data bit	8	7 or 8	
Stop bit	1	1 or 2	
Parity	Even parity	Even/odd/no parity	
Baud rate	19200	4800/38400/9600/115200/19200/187500	
Station no.	1	0~255	

Note: please set the communication wait time if the connection is error.

The screenshot shows a 'Communication Parameter' dialog box with the following settings:

- Baudrate:** 4800, 56000, 9600, 57600, 19200 (selected), 115200, 38400, 187500
- Data Bit:** 7Bits, 8Bits (selected)
- Stop Bit:** 1Bit (selected), 2Bits
- Parity check:** None, Odd, Even (selected)
- Wait:** Communication Time: 10 (highlighted in red), MSEL
- Send Data:** checked
- Vir Station:** unchecked
- Retry times:** 3
- Exchange WORD:** unchecked

Inverter:

Function code	Name	Range	Meaning
---------------	------	-------	---------

P0.01	Frequency setting channel	4	Serial port setting
P0.03	Run command channel	2	Run via serial port
P3.09	Communication settings	054	The unit: 19200 Decade: 1-8-1, even parity Hundred: no definition

2.29.3 Cable making

RS485:

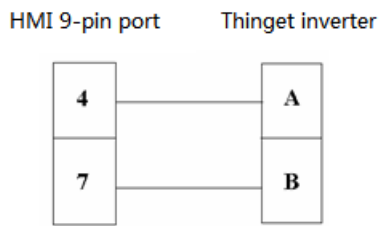

Fig1

2.30 SHIMADEN

2.30.1 Device model

Series	Connected module	Port	Cable	Device
SRS10(SRS11/SRS13/SRS14) Digital adjustor	RS485 on the cpu unit	RS485	Fig 1	Modbus RTU (panel is Master)

Note: all the devices support Modbus protocol can communicate with Touchwin HMI.

2.30.2 Parameters

HMI:

Parameters	Recommend settings	Choices of settings	Note
PLC type	Modbus RTU (panel is Master)		
Port	RS485	RS485	
Data bit	8	7 or 8	
Stop bit	1	1 or 2	
Parity	Even parity	Even/odd/no parity	
Baud rate	9600	4800/38400/9600/115200/19200/187500	
Station no.	1	0~255	

Note:

1. The parameters of device and HMI must be same.
2. Some devices need to add terminal resistor (such as SRS10 digital adjustor)
3. Meter parameter 018C must set to 1 (COM LED is ON), please use the “function filed”(the button in the Touchwin software) to set the value of 018C(4x396=1).

2.30.3 Cable making

RS485 connection:

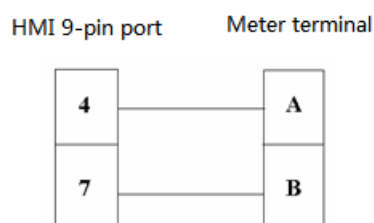

Fig1

2.30.4 Device address

PLC address (Hex)	Parameters	Read/write	Meaning
0100	PV	Read	Measured value
0101	SV	Read	Setting value
0102	OUT1	Read	Output 1
0103	OUT2	Read	Output 2
0104	EXE_FLG	Read	Status sign
0105	EV_FLG	Read	event output sign
0300	FIX SV1	Read/write	Fixed value 1
0301	FIX SV2	Read/write	Fixed value 2
0302	FIX SV3	Read/write	Fixed value 3
030A	SV_L	Read/write	Lower limit of settings
030B	SV_H	Read/write	Upper limit of settings

2.31 Modbus RTU (panel is Master)

2.31.1 Device model

Series	Port	Cable	Device
Devices support Modbus RTU protocol	RS485	Fig 1	Modbus RTU (panel is Master)
	RS232	Fig 2	
	RS422	Fig 3	

2.31.2 Parameters

HMI:

Parameters	Recommend settings	Choices of settings	Note
PLC type	Modbus RTU (panel is Master)		
Port	RS485	RS485/RS232/RS422	
Data bit	8	7 or 8	
Stop bit	1	1 or 2	
Parity	Even parity	Even/odd/no parity	
Baud rate	9600	4800/38400/9600/115200/19200/187500	
Station no.	1	0~255	

Note:

1. Modbus RTU protocol supports broadcast function, station no is 0.
2. How to use the broadcast function in the HMI?

The broadcast function only sends command but not receives. It sends command by “function field”, “function button” or “function block” in Touchwin software. The operand must has no feedback command, such as “set on coil”, “setting data”, “reset coil”.

PLC:

Please choose Modbus RTU (Slave) in the software.

2.31.3 Cable making

(a) Modbus RS485:

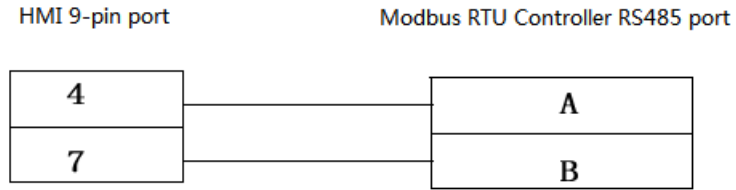

Fig1

(b) Modbus RS232:

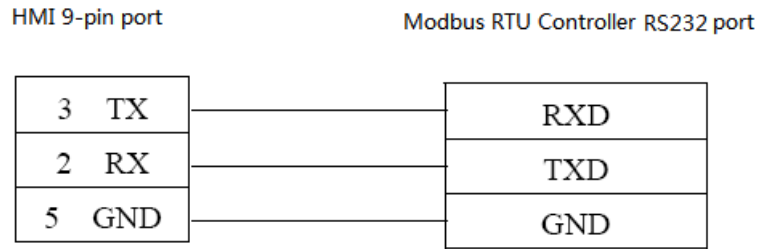

Fig2

(c) Modbus RS422:

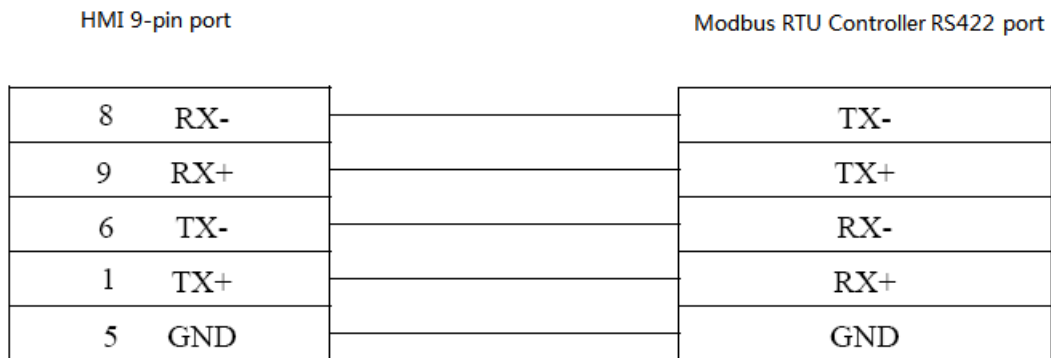

Fig3

2.31.4 Device address

Device address	Range	Data type	Feature	Explanation
0x	0~65535	Bit	R/W	External I/O /internal coil
1x	0~65535	Bit	R	External I/O /internal coil
4x	0~65535(0~15)	Bit	R/W	External I/O /internal coil
4x	0~65535	Word/Dword	R/W	Used as data register
3x	0~65535	Word/Dword	R	Used as data register

2.32 Modbus ASCII (Panel is Master)

2.32.1 Device model

Series	Port	Cable	Device
The device support Modbus ASCII protocol	RS485	Fig 1	Modbus ASCII (panel is Master)
	RS232	Fig 2	
	RS422	Fig 3	

2.32.2 Parameters

HMI

Parameters	Recommend settings	Choices of settings	Note
PLC type	Modbus ASCII (panel is Master)		
Port	RS485	RS485/RS232/RS422	
Data bit	8	7 or 8	
Stop bit	1	1 or 2	
Parity	Even parity	Even/odd/no parity	
Baud rate	9600	4800/38400/9600/115200/19200/187500	
Station no.	1	0~255	

PLC:

Please choose Modbus ASCII (Slave) protocol in the software.

2.32.3 Cable making

Modbus RS485:

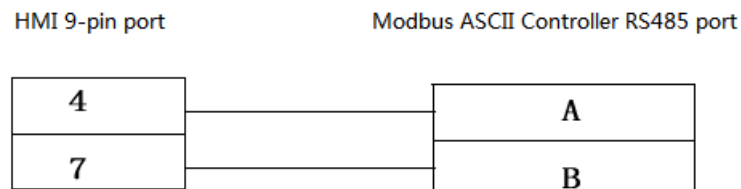

Fig1

Modbus RS232:

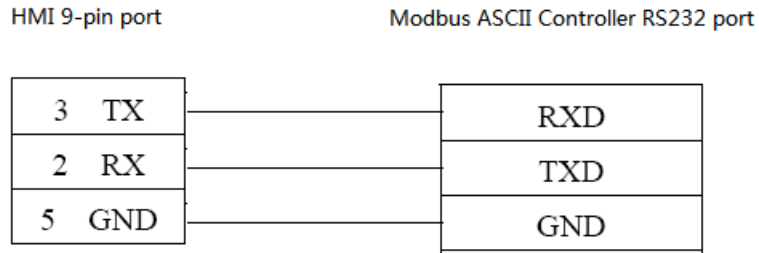

Fig2

Modbus RS422:

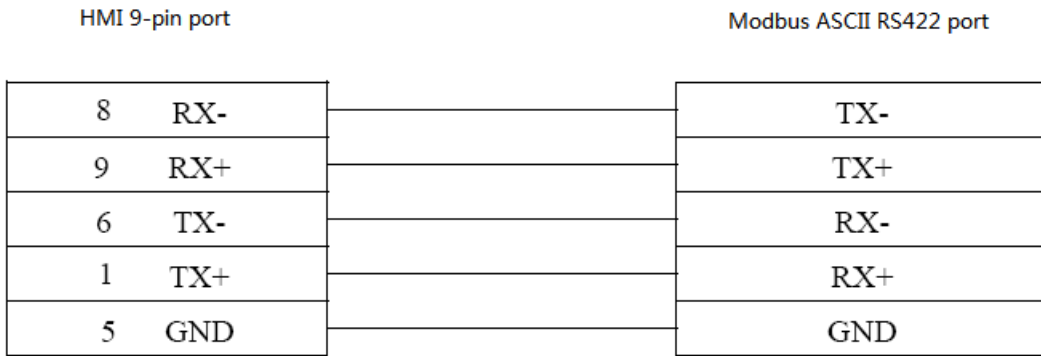

Fig3

2.32.4 Device address

Device address	Range	Data type	Explanation
0x	0~65535	Bit	External I/O/internal coil
1x	0~65535	Bit	External I/O/internal coil
4x	0~65535	Word/Dword	Used as data register
3x	0~65535	Word/Dword	Used as data register

2.33 Modbus slave (panel is Slave)

2.33.1 Device model

Series	Port	Cable	Device
The device support Modbus protocol	RS485	Fig 1	Modbus slave (panel is Slave)
	RS232	Fig 2	
	RS422	Fig 3	

2.33.2 Parameters

HMI:

Parameters	Recommend settings	Choices of settings	Note
PLC type	Modbus slave (panel is slave)		
Port	RS485	RS485/RS232/RS422	
Data bit	8	7 / 8	
Stop bit	1	1 / 2	
Parity	Parity	Even/odd/no parity	
Baud rate	9600	4800/38400/9600/115200/19200/187500	
Station no.	1	0~255	

2.33.3 Cable making

Modbus RS485:

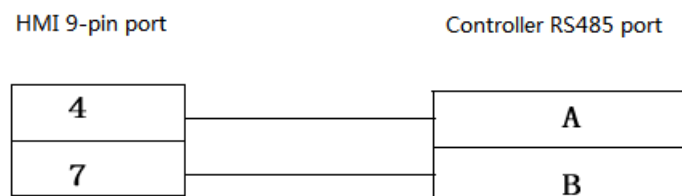

Fig1

Modbus RS232:

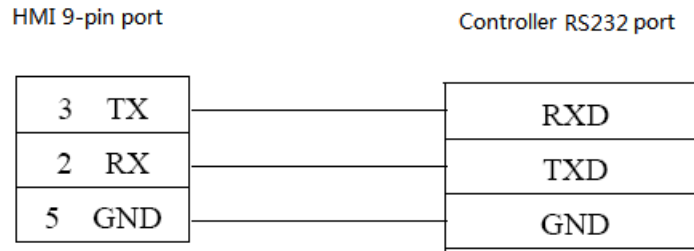

Fig2

Modbus RS422:

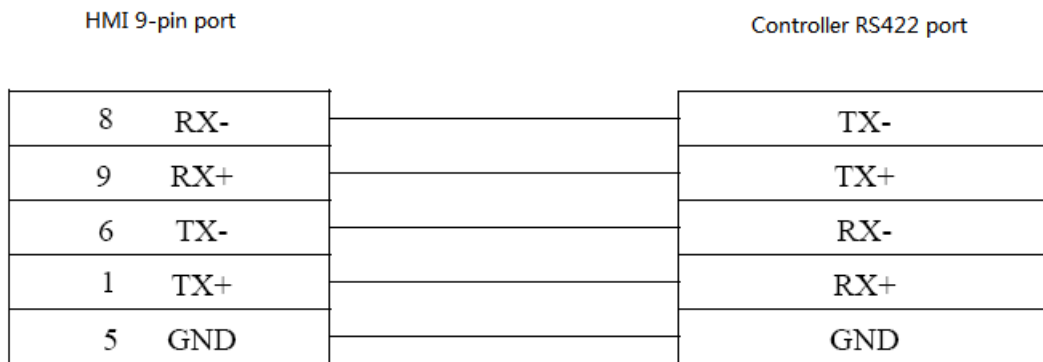

Fig3

2.33.4 Device address

Device address	Range	Data type	Features	Explanation
0x	0~65535	Bit	R/W	External I/O/internal coil
1x	0~65535	Bit	R	External I/O/internal coil
4x	0~65535	Word/Dword	R/W	Used as data register
3x	0~65535	Word/Dword	R	Used as data register

2.34 ABB PLC

2.34.1 Device model

ABB PLC can communicate with Touchwin HMI by Modbus protocol.

Series	Port	Cable	Device
AC500	PM564-T-ETH	Fig 1	ABB (AC500)

2.34.2 Parameters

HMI:

Parameters	Recommend settings	Choices of settings	Note
PLC type	ABB AC500		
Port	RS485	RS485	
Data bit	8	7 or 8	
Stop bit	1	1 or 2	
Parity	Even parity	Even/odd/no parity	
Baud rate	19200	4800/38400/9600/115200/19200/187500	
Station no.	1	0~255	

PLC:

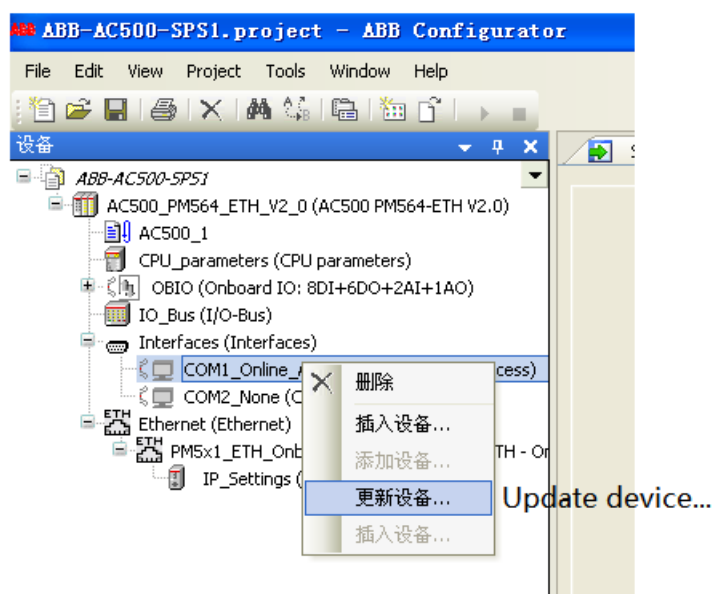

1. Choose Modbus in ABB AC500 PLC serial port:



2. Choose COM1 MODBUS, then set the operation mode to slave. Other parameters should be the same to HMI.

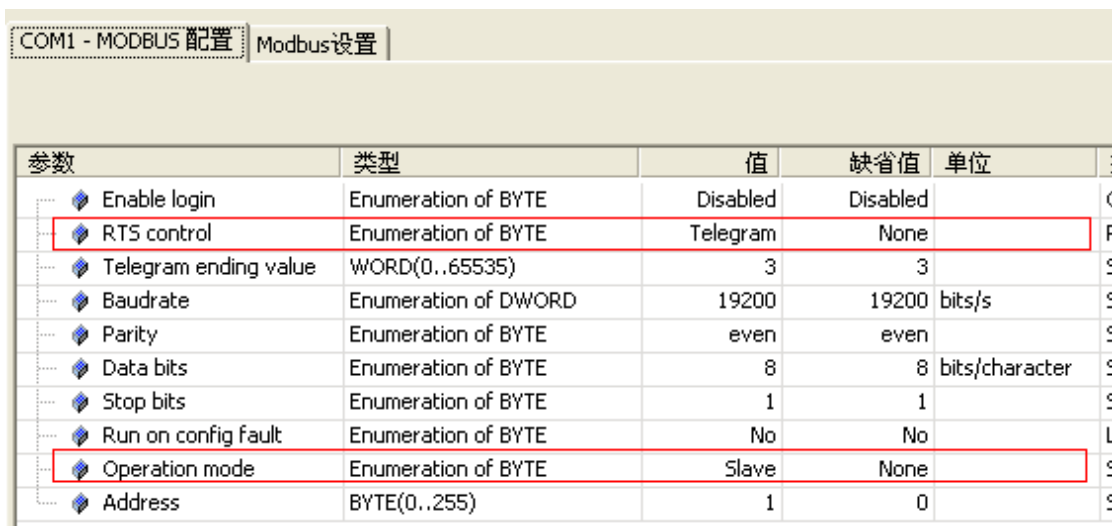

2.34.3 Cable making

ABB COM1 (RS-485):

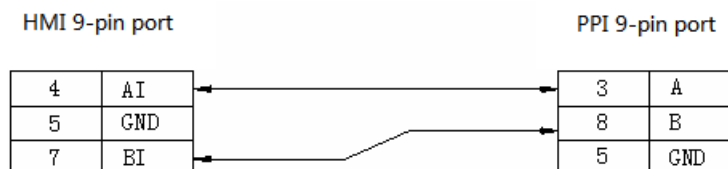

2.34.4 Device address

PLC address	Range	Data type	Explanation
MX0	0.0.0~0.65535.7	Bit	External I/O/internal coil
MX1	0.0.0~0.65535.7	Bit	External I/O/internal coil
MW0	0~32767	Word//DWord	Data register
MW1	0~32767	Word//DWord	Data register
MD0	0~32767	Word//DWord	Data register
MD1	0~32767	Word//DWord	Data register

2.35 IDEC

2.35.1 Device type

Series	Connected module	Port	Cable	Choose PLC type in Touchwin software
MicroSmart	RS232 on the cpu unit	RS485	Fig 1	IDEC MicroSmart

2.35.2 Parameters

HMI settings:

Parameters	Recommend settings	Choices of settings	Note
PLC type	IDEC MicroSmart		
Port	RS232	RS232	
Data bit	7	7/8	
Stop bit	1	1/2	
Parity	Even parity	Even /odd /no parity	
Baud rate	9600	4800/38400/9600/115200/19200/187500	
Station no.	0		

2.35.3 Cable making

RS232 connection:

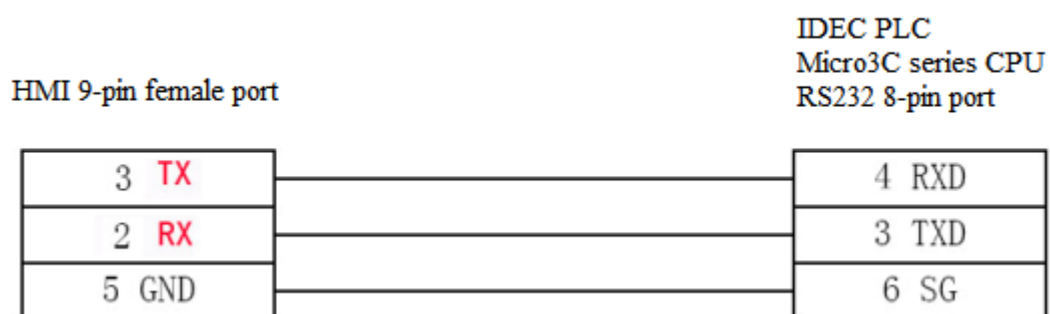

2.35.4 Device address

Device address	Range	Data type	Explanation
D	0~8199	Word/DWord	Data register
W	0~6	Word	Data register
T	0~99	Word	Timer
t	0~99	Word	Timer
C	0~99	Word	Counter
c	0~99	Word	Counter
R	0~127	Word	Data register
x	0.0~30.7	Bit	Input
y	0.0~30.7	Bit	Output
m	0.0~807.7	Bit	Auxiliary relay
r	127	Bit	Auxiliary relay

2.36 TAIAN

2.36.1 Device type

Series	CPU	Connected module	Port	Cable	Choose PLC type in Touchwin software
TAIAN	TP03-20HR-A	RS232 on the CPU Unit	RS232	Fig 1	TAIAN TP03 series
	TP03-30HR-A	RS485 on the CPU Unit	RS485	Fig 2	

2.36.2 Parameters

HMI settings:

Parameters	Recommend settings	Choices of settings	Note
PLC type	TAIAN TP03 series		
Port	RS232	RS232/RS485	
Data bit	8	7/8	
Stop bit	2	1/2	
Parity	No parity	Even /odd /no parity	
Baud rate	19200	4800/38400/9600/115200/19200/187500	
Station no.	1	0-255	

2.36.3 Cable making

RS232 connection:

HMI 9-pin D-type female port PLC 8-pin round male port

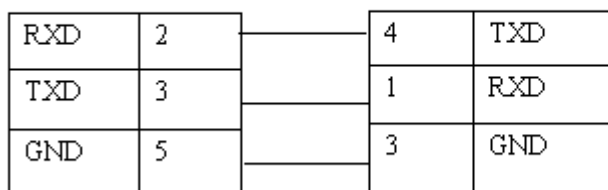

Fig1

RS485 connection:

HMI 9-pin D-type female port PLC RS485 terminal

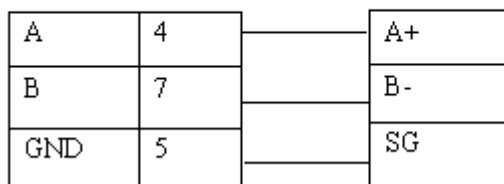

Fig2

2.36.4 Device address

Device address	Range	Data type	Explanation
D	0~8511	Word/DWord	Data register
T	0~511	Word/DWord	Timer
C	0~255	Word/DWord	Counter
X	0~377	Bit	Input
Y	0~377	Bit	Output
M	0~1535	Bit	Auxiliary relay
S	0~1023	Bit	Auxiliary relay
T	0~511	Bit	Timer
M8xxx	0~511	Bit	Auxiliary relay
C	0~255	Bit	Counter
S expansion	1024~4095	Bit	Auxiliary relay
M expansion	1536~7679	Bit	Auxiliary relay

2.37 YuDian AI

2.37.1 Device address

Series	Connected module	Port	Cable	Choose PLC type in Touchwin software
AI	RS485 on the cpu unit	RS485	Fig 1	AI series instrument

2.37.2 Parameters

HMI settings:

Parameters	Recommend settings	Choices of settings	Note
PLC type	AI series instrument		
Port	RS485	RS485	
Data bit	8	7/8	
Stop bit	1	1/2	
Parity	No parity	Even /odd /no parity	
Baud rate	9600	4800/38400/9600/115200/19200/187500	
Station no.	129		

Note:

1. The parameters of HMI and meter must be the same.
2. How to set the station no. of meters?
HMI→129 meter→ 1+80H
HMI→130 meter→ 2+80H

2.37.3 Cable making

RS485 connection:

HMI 9-pin D-type female port meter terminal

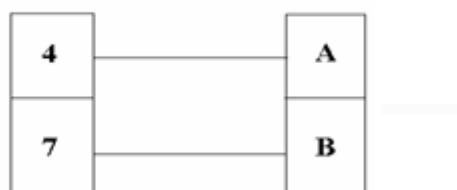

2.37.4 Device address

Device address	Range	Data type	Explanation
PV	0~100	Read	Measure value
SV	0	read/write	Set value
MV	0	Read	Output value
Flow meter MV	0	Read	Output value of flow meter
S	0/1	Read	Status bit

2.38 Inovance PLC

2.38.1 Device type

Series	CPU	Connected module	Port	Cable	PLC type in touchwin software
H1U	H1U-0806MR\T H1U-1410MR\T H1U-1614MR\T	CPU	RS422	Fig 1	Mitsubishi FX series PLC
H2U	H2U-1616MR\T H2U-2416MR\T H2U-3624MR\T				

2.38.2 Parameter

HMI settings

Parameter	Recommended settings	Choices of settings	Notes
PLC type	FX series	-	-
Data bit	7	-	
Stop bit	1	-	
Parity	Even parity	Even/odd/no parity	
Baud rate	9600	4800/9600/19200/38400/56000/ 57600/ 115200/187500	
Station no.	0	-	

Inovance H1U\2U series default communication parameters: 9600, 7, 1, even, statio no.0

PLC settings:

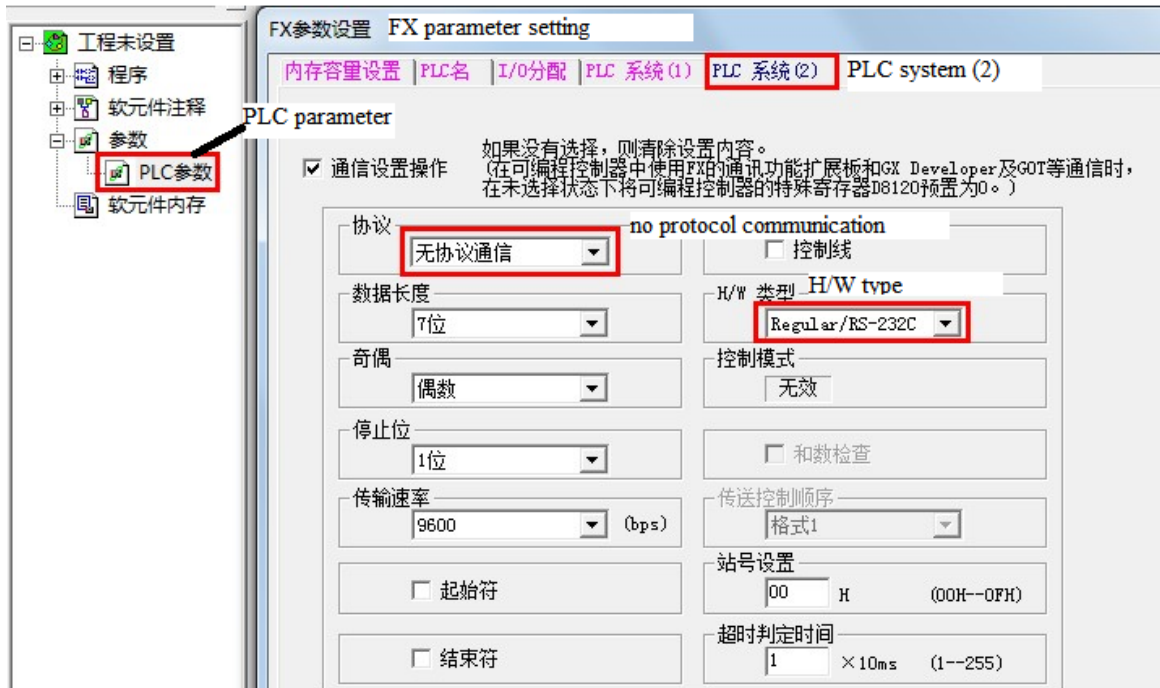

2.38.3 Cable making

(a) HIU\2U series PLC RS422 port:

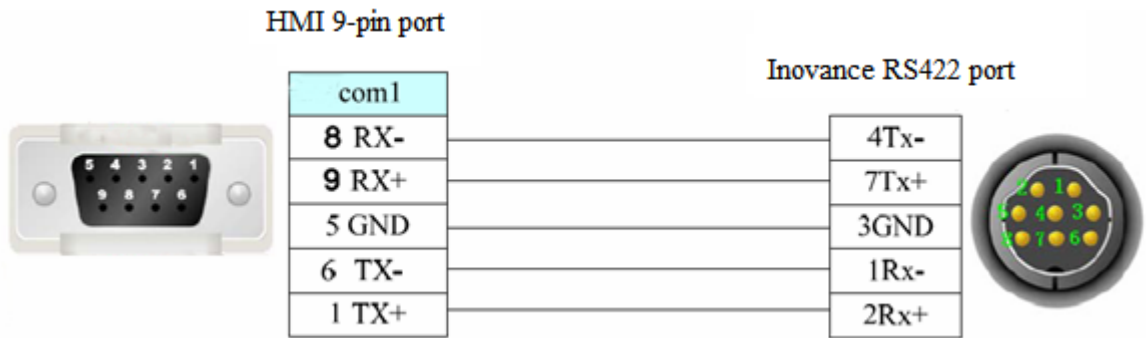

Fig1

2.38.4 Device address

PLC address	Range	Object	Explanation
X	0~177	Bit	External input terminal
Y	0~177	Bit	External output terminal
M	0~8255	Bit	Internal auxiliary coil
S	0~999	Bit	Stepper coil
T	0~255	Bit	Timer
C	0~255	Bit	Counter

C16	0~199	Word/DWord	16-bit counter
C32	200~255	DWord	32-bit counter
D	0~8255	Word/DWord	Data register
T	0~255	Word/DWord	Current value
X	0~177	Word/DWord	Used as data register
Y	0~177	Word/DWord	Used as data register
M	0~8255	Word/DWord	Used as data register
S	0~999	Word/DWord	Used as data register

2.39 HaiWell PLC

2.39.1 Device type

Series	CPU	Connected module	Port	Cable	PLC type in Touchwin software
E\S	HW-S16ZR220R	CPU	RS232	Fig 1	Modbus RTU (panel is master)
			RS485	Fig 2	

2.39.2 Parameters

HMI settings:

Parameter	Recommend settings	Choices of settings	Notes
PLC type	Modbus RTU (panel is master)	-	-
Data bit	8	-	
Stop bit	1	-	
Parity	Odd	Even/odd/no parity	
Baud rate	9600	4800/9600/19200/38400/ 56000/ 57600/115200/187500	
Station no.	1	-	

Haiwell E\S series default communication parameters: 9600, 8, 1, odd, station no.1

PLC settings:

Communication protocol: Modbus RTU.

2.39.3 Cable making

(a) E\S series PLC RS232:

Haiwell PLC port	RS232 connection	HMI port
 <p>4-pin S-type male port (same to programming cable)</p>	<p>TX 2 ————— 2 RXD</p> <p>RX 1 ————— 3 TXD</p> <p>GND 3 ————— 5 GND</p>	 <p>9-pin D-type female port</p>

Fig 1

(b) E\S series PLC RS485:

Haiwell PLC port	RS485 connection	HMI port
 <p>A+ B-</p>	<p>A+ ————— 4 AI</p> <p>B- ————— 7 BI</p>	 <p>9-pin D-type female port</p>

Fig 2

2.39.4 Device address

PLC address	Range	Modbus address	Read/write	Explanation
X	X0~X1023	0~1023	Read	Input
Y	Y0~Y1023	1536~2559	Read/write	Output
M	M0~M12287	3072~15359	Read/write	Internal coil
T	T0~T1023	15360~16383	Read/write	Timer
C	C0~C255	16384~16639	Read/write	Counter
SM	SM0~SM215	16896~17111	Read/write partly	System state bit
S	S0~S2047	28672~30719	Read/write	Stepper state bit
CR		00~4F	Read/write partly	Register for analog and special module
AI	AI0~AI255	0000~00FF	Read	Input register for analog
AQ	AQ0~AQ255	0100~01FF	Read/write	Output register for analog
V	V0~V14847	0200~3BFF	Read/write	Internal register
TCV	TCV0~TCV1023	3C00~3FFF	Read/write	Timer
CCV	CCV0~CCV255	4000~40FF	Read/write	Counter
SV	SV0~SV154	4400~448B	Read/write partly	System register

2.40 Hollias PLC

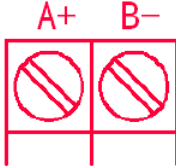
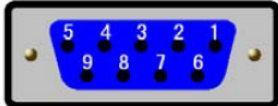
2.40.1 Device type

Series	CPU	Connected module	Port	Cable making	PLC type in Touchwin software
LM	LM3109	CPU	RS232	Fig 1	Modbus RTU (panel is master)
	LM3107		RS485	Fig 2	

2.40.2 Parameters

HMI settings:

Parameters	Recommend settings	Choices of settings	Note
PLC type	Modbus RTU (panel is master)	-	-
Data bit	8	-	
Stop bit	1	-	
Parity	No parity	Even/odd/no parity	
Baud rate	38400	4800/9600/19200/38400/56000/ 57600/115200/187500	
Station no.	51	-	

Hollias LM series PLC default parameters: 38400, 8, 1, no parity, station no.51

2.40.3 Cable making

(a) LM series PLC RS232:

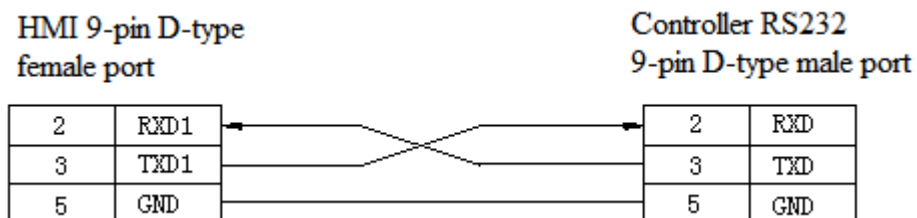

Fig1

(b) LM series PLC RS485:

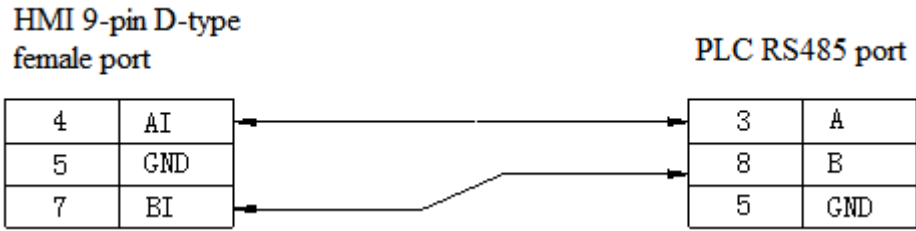

Fig2

2.40.4 Device address

Please refer to Hollias PLC Modbus address list.

The address is decimal value in HMI.

0x: read/write coil 1x: only read coil 4x: read/write register 3x: only read register

2.41 Delta (temperature controller)

2.41.1 Device type

Series	CPU	Connected module	Port	Cable	PLC type in Touchwin software
DVP	DTA4848 DTA9696VR DTC1000 DTC2000	CPU	RS485	Fig 1	Modbus RTU (panel is master)

2.41.2 Parameters

HMI settings:

Parameters		Choices of settings	Notes
PLC type	Modbus RTU (panel is master)	-	-
Data bit	7	-	
Stop bit	1	-	
Parity	Even parity	Even/odd/no parity	
Baud rate	9600	4800/9600/19200/38400/56000/57600/ 115200/187500	
Station no.	1	-	

Delta (temperature controller) default parameters: 9600, 7, 1, even parity, station no.1

2.41.3 Cable making

(a) DVP RS485

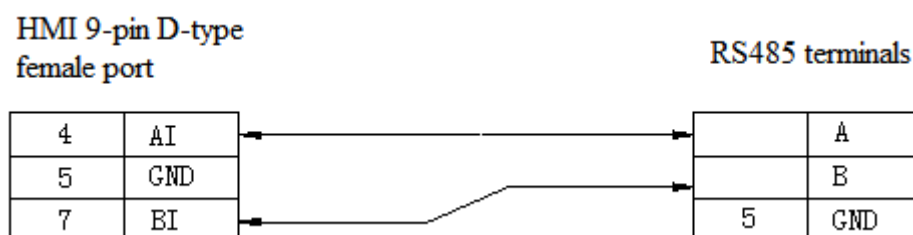

Fig1

2.41.4 Device address

Please refer to Delta temperature controller Modbus address list.

The address is decimal in HMI.

0x: read/write coil 1x: only read coil 4x: read/write register 3x: only read register

2.42 Siemens S7-1200

2.42.1 Device type

Series	Communication type	Connection diagram	PLC type in Touchwin software
Siemens S7-1200	RJ45	Diagram 1 or 2	Siemens S7-1200 series

2.42.2 Parameters

We take Siemens S7-1200 CPU1211C 6ES7 211-1BD30-0XB0 PLC as an example to explain the settings.

PLC software settings:

1. Open project-devices&networks-normal-Ethernet IP, set the PLC IP address:

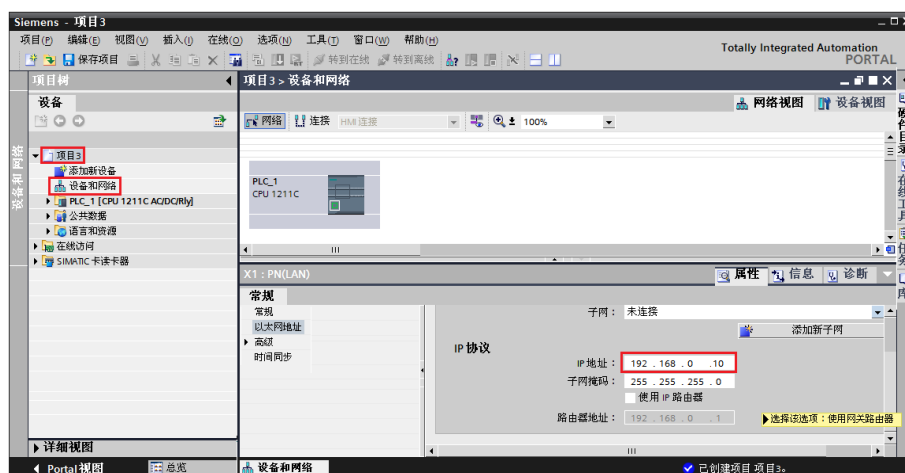

2. PLC DB, M must be defined in the PLC before using. Click project-program block-add new block, choose data block (DB), the type is global DB, not choose only sign visit. DB number can be auto or manual.



3. Choose project-program block-data block can define the address in the data block.

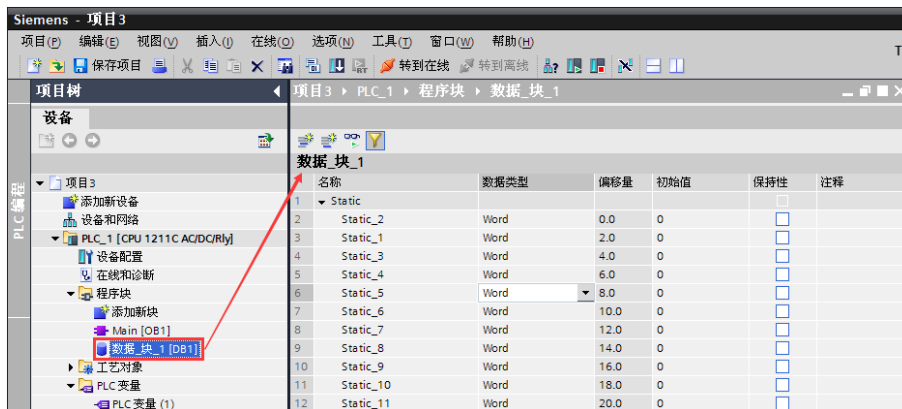

Note: for the software STEP Basic V12 and up version, please release the communication protection:

(1) Choose the PLC model in the project tree, right click it, choose properties



(2) Please choose “permit access with PUT/GET communication from remote partner (PLC, HMI, OPC)”. Then download the PLC program in the PLC.

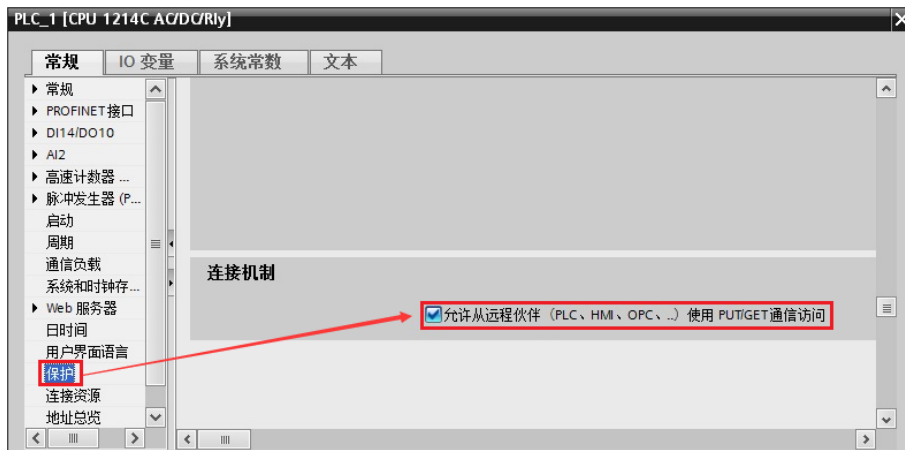

HMI settings:

Only Touchwin software v2.d.1j and higher version support Siemens 1200 series PLC.

Operation steps:

- (1) Please select the HMI type, click next.

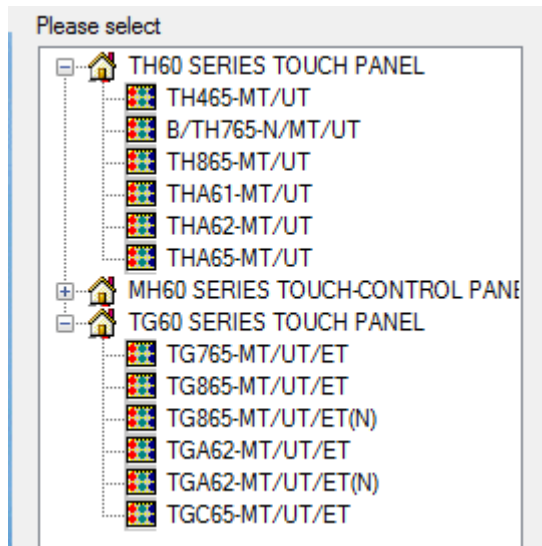

- (2) Select Net device. The IP address in own devices is HMI IP address.

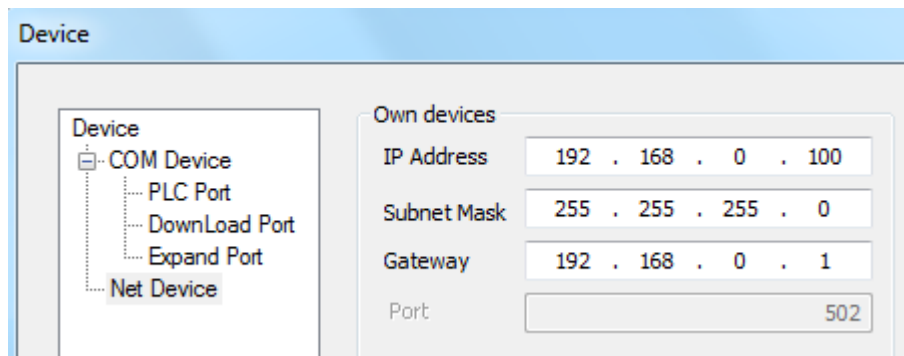

(3) Right click Net device, click New. Then input the project name.

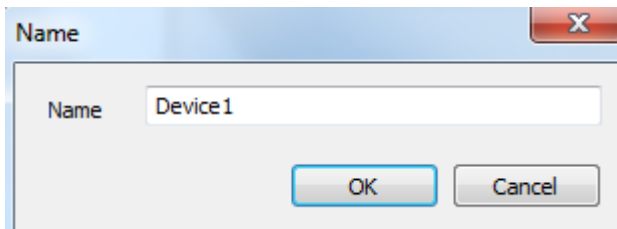
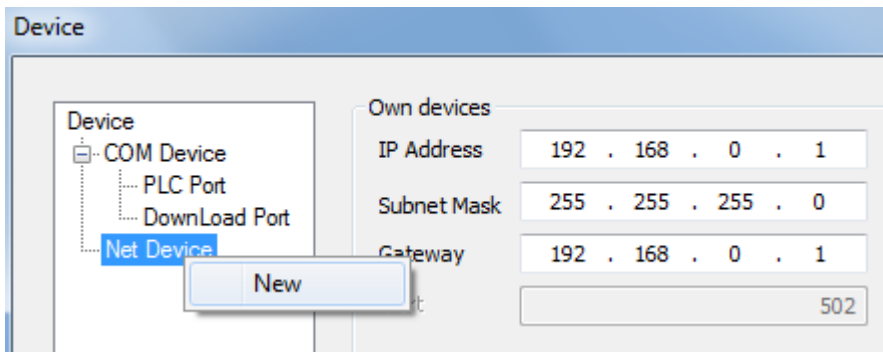

(4) Right click the project name to delete or rename the project.

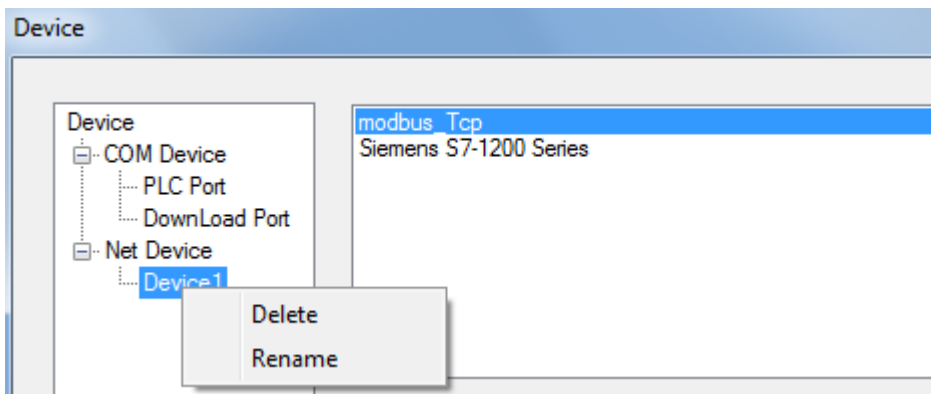

(5) Select Siemens S7-1200 series in the device list.

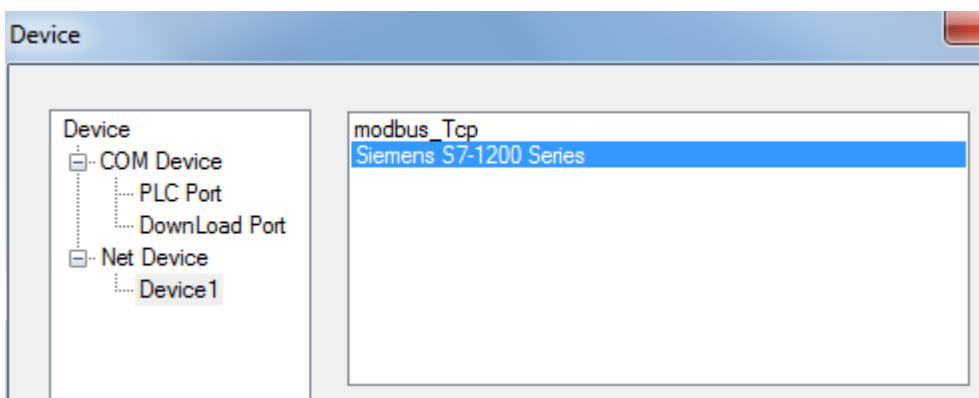

(6) The IP is S7-1200 IP address. Note: this IP can be set in PLC software. Port 102 cannot be changed.

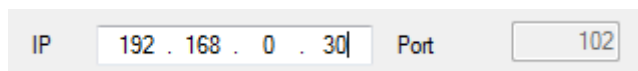

(7) please choose “word exchange”, otherwise, the double word data will be error.

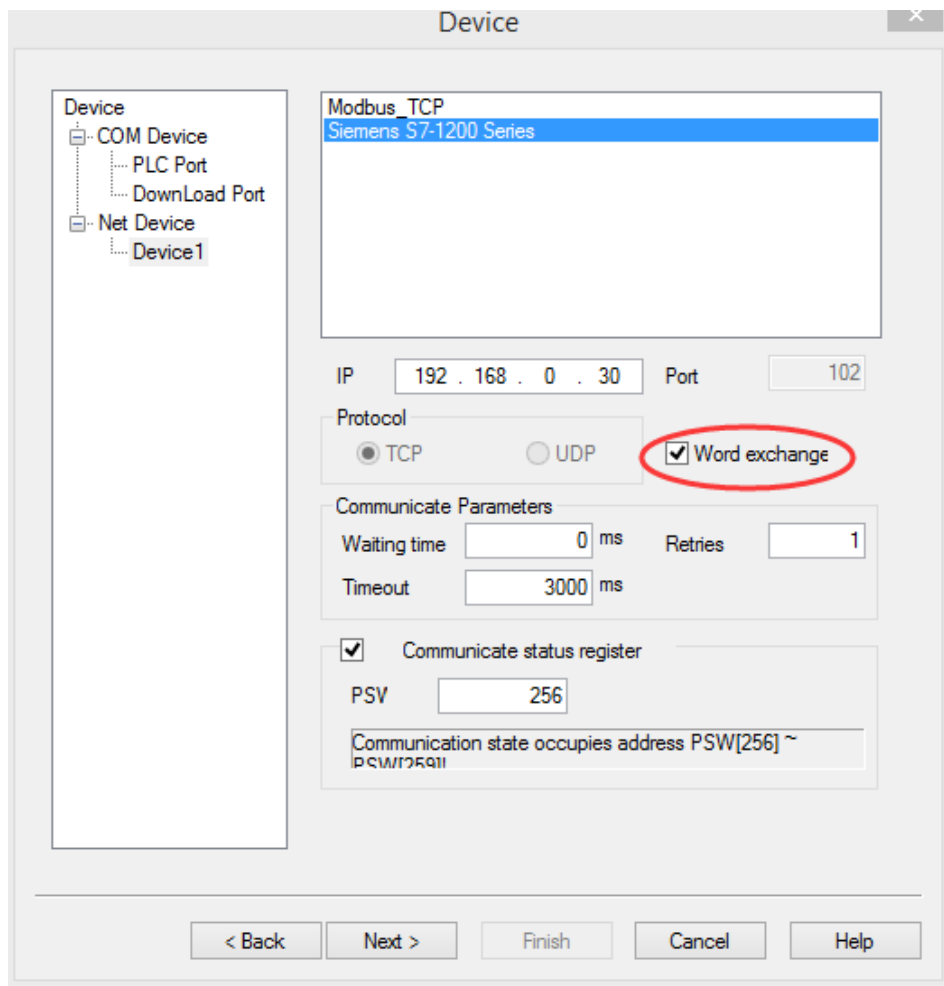

(8) Communication parameters: please use the default parameters.

(9) Communication status register: if select this item, the status will occupy 4 registers. The register address can be set by user. If set the address to PSW256, the register meanings are shown as the following.

- PSW256: communication succeeded times
- PSW257: communication failed times
- PSW258: timeout times
- PSW259: communication error times.

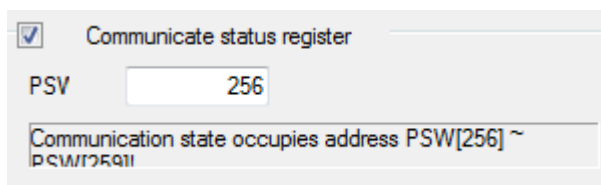

(10) Then click next to finish the project setup.

(11) In the editing screen, when user defines the button object, please select device 1.

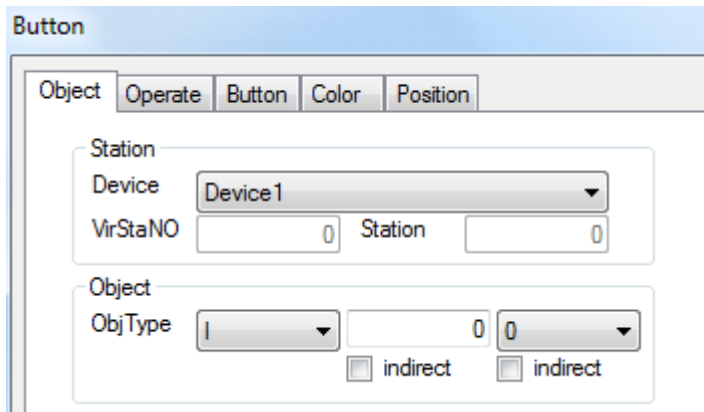

Note: please define the DB and M in the Siemens PLC, otherwise the communication will be error.

(12) Notes:

- A. Siemens PLC S7-1200 doesn't have station number problem. It can build network with HMI once the IP address is correct. The network mode can be multi-HMI-one-PLC, one-HMI-multi-PLC, and multi-PLC-multi-HMI.
- B. RX/TX lights when the communication is successful. RX/TX is shining when it is finding the network.
- C. Modbus TCP device is used to connect with TBOX-XINJE PLC; Siemens S7-1200 device can connect any device with Ethernet.
- D. please define the DB and M in the Siemens PLC, otherwise the communication will be error.

2.42.3 Cable making

RJ45 straight through cable (connect HUB) or RJ45 crossover cable:

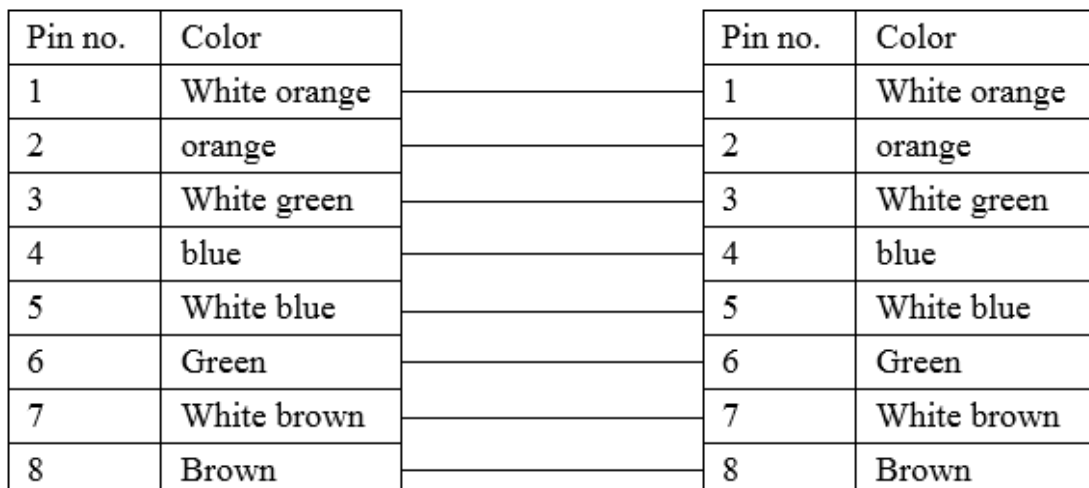

Diagram 1

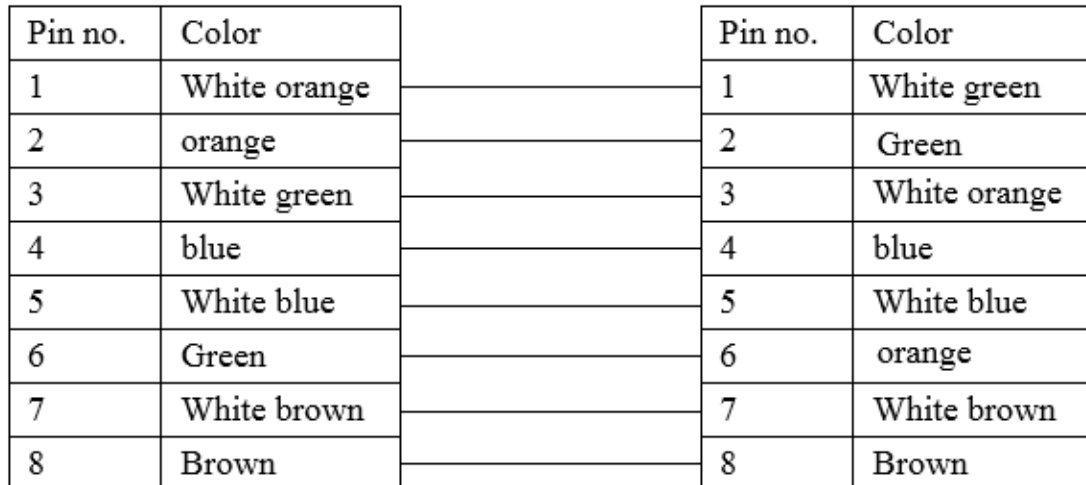

Diagram 2

2.42.4 Device address

PLC address type	Range	Object type	Explanation
I	0~9999	Byte/Word/DWord	Input register
Q	0~9999	Byte/Word/DWord	Output register
M	0~9999	Byte/Word/DWord	Internal auxiliary register
DB0~DB20	0~9999	Byte/Word/DWord	Data register
I	0.0~9999.7	Bit	Input
Q	0.0~9999.7	Bit	Output
M	0.0~9999.7	Bit	Auxiliary relay
DB0~DB20	0.0~9999.7	Bit	Auxiliary relay

2.43 Mitsubishi FR series inverter

2.43.1 Device type

Series	Connect module	Communication type	Cable diagram	PLC type in Touchwin software
FR	RS485 port on CPU unit	RS485	diagram 1	Mitsubishi FR series inverter
				Modbus RTU (panel is Master)

2.43.2 Parameters

Choose Mitsubishi FR series inverter:

HMI:

Parameters	Recommended setting	Choices of settings	Notes
PLC type	Mitsubishi FR series	-	-
Port type	RS485	RS485	
Data bit	8	-	
Stop bit	2	-	
Parity	Even parity	-	
Baud rate	19200	9600/115200/19200/187500	
Station no.	0	0~31	

Inverter parameters:

Function (FR)	Name	Default value	Range	Debug parameters
P117	Station no.	0	0~31, 0~247	0
P118	Baud rate	19.2kbps	4800bps,9600bps,38400bps	19200
P119	Stop bit, data bit	1	0: 1 stop bit, 8 data bit 1: 2 stop bit, 8 data bit 10: 1 stop bit, 7 data bit 11: 2 stop bit, 7 data bit	1: 2 stop bit, 8 data bit
P120	Parity	2	0: no parity 1: odd parity 2: even parity	2: even parity
P121	Retry times	9999		9999
P122	Test time	0	0: RS485 9999: no communication test	0

P123	Wait time	150ms		125
P124	R/LF	0	0: without CR, LF 1: with CR 2: with R, LF	0
P79	Mode selection	0	0~7	Set to 2, external communication mode, please cut off the power of inverter after setting the parameters
P340	Communication start mode	0	0, 1, 10	Set to 1, start in network running mode

Select Modbus RTU (Panel is Master):

HMI:

Parameter	Recommended settings	Choices of settings	Note
PLC type	Modbus Rtu (Panel is Master)	-	-
Port type	RS485	RS485	
Data bit	8	-	
Stop bit	2	-	
Parity	Even parity	-	
Baud rate	19200	9600/115200/19200/187500	
Station no.	1	0~31	

The image shows a 'Communication Parameter' dialog box with the following settings:

- Baudrate:** 19200 (selected), 4800, 56000, 9600, 57600, 115200, 38400, 187500.
- Data Bit:** 8Bits (selected), 7Bits.
- Stop Bit:** 2Bits (selected), 1Bit.
- Parity check:** Even (selected), None, Odd.
- Wait:** Communication Time: 0 MSEL.
- Send Data:** Send Data, Vir Station.
- Retry times:** 3.
- Exchange WORD:** Exchange WORD.

Inverter parameters:

Function (FR)	Name	Default value	Range	Debug parameters
P117	Station no.	1	0~31, 0~247	1 (Modbus station no. can not be 0)
P118	Baud rate	19.2kbps	4800bps,9600bps,38400 bps	19200
P119	Stop bit	1	0: 1 stop bit, 8 data bit 1: 2 stop bit, 8 data bit 10: 1 stop bit, 7 data bit 11: 2 stop bit, 7 data bit	1: 2 stop bit, 8 data bit
P120	Parity	Even	0: no parity 1: odd parity 2: even parity	2: even parity
P121	Retry times	9999		9999
P122	Communication test	0	0: RS485 9999: no communication test	0
P123	Waiting time	150ms		125
P124	CR/LF selection	0	0: without CR, LF 0: with CR 0: with R, LF	0
	549 protocol selection	1	Modbus-RTU	Be valid after restart the inverter
P79	Mode selection	0	0~7	Set to 2, external

				communication mode, please cut off the power of inverter after setting the parameters
P340	Communication start mode	0	0, 1, 10	Set to 1, start in network running mode

2.43.3 Cable making

RS485 cable:

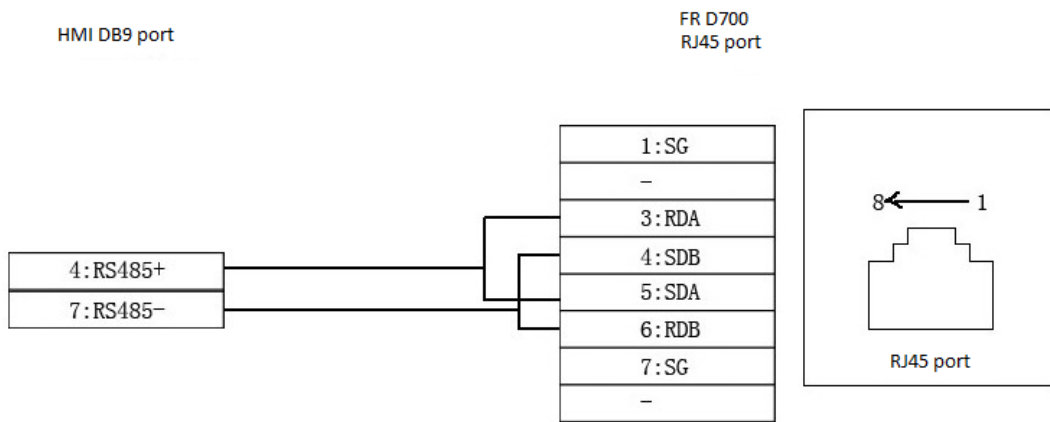

Diagram 1

2.44 Sanken VM06 inverter

2.44.1 Device type

Series	Port type	Cable diagram	PLC type in Touchwin software
VM06	RS485	diagram 1	Sanken VM06 inverter
			Modbus RTU (Panel is master)

2.44.2 Parameters

Select Sanken VM06 inverter:

HMI:

Parameter	Recommended setting	Choices of setting	Note
PLC type	Sanken VM06 inverter	-	-
Port type	RS485	RS485	
Data bit	8	-	
Stop bit	1	-	
Parity	Even parity	-	
Baud rate	9600	9600/115200/19200/187500	
Station no.	1	0~31	

Select Modbus RTU (Panel is master)

HMI:

Parameter	Recommended setting	Choices of setting	Note
PLC type	Modbus Rtu (Panel is master)	-	-
Port type	RS485	RS485	
Data bit	8	-	
Stop bit	1	-	
Parity	Even parity	-	
Baud rate	9600	9600/115200/19200/187500	
Station no.	1	0~31	

Communication Parameter

Baudrate
 4800 56000
 9600 57600
 19200 115200
 38400 187500

Data Bit
 7Bits 8Bits

Stop Bit
 1Bit 2Bits

Parity check
 None Odd Even

Wait
 Communication Time MSEL

Send Data Vir Station Retry times

Exchange WORD

OK Cancel

Inverter:

Function	Name	Content	Debug parameters
F1002	Frequency setting	1: operate panel 2: external analog voltage VIF1 (0~5V) 21: terminal stepper 22: communication	22
F1101	Running command selection	1. Operate panel 2. External terminals 3. communication	3
F4002	RS232C/RS485	1: RS232C (default setting) 2: RS485	Choose according to wiring method
F4005	Serial communication function	0: no function (default setting) 1: special protocol communication 2: Modbus communication	2
F4006	Inverter station no.	0~254: ModBus station no. (1~32: RS485 communication) 1~32 is valid in special protocol communication	1
F4007	Baud rate	1: 1200bps 2: 2400bps 3: 4800bps 4: 9600bps 5: 19200bps 6: 38400bps 7: 57600bps	4
F4008	Parity	0: no 1: odd (default setting) 2: even	2
F4009	Stop bit	1: 1 bit (default setting)	1

		2: 2 bit	
F4010	Stop code	0: CR+LF (default setting) 1: CR ※ BINARY and Modbus without stop code	0

2.44.3 Cable making

RS485:

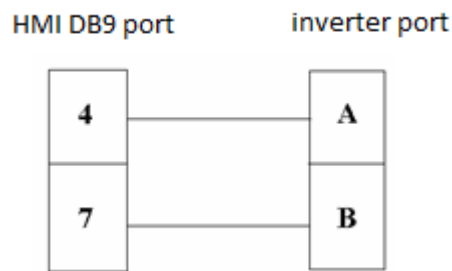

Diagram 1

2.44.4 Device address

Inverter Modbus address

Function code	Upper limit frequency	33775	Data input/display
	Setting frequency	34869	Function button-set data
Register	Forward running	1001	Function button (2)
	Reverse running	1001	Function button (8)
	Setting frequency	1000	Function button

2.45 XINJE XD/XE series

2.45.1 Device type

Series	CPU	Connection	Communication	Cable	Choose PLC type in Touchwin
XD/XE	XD3/XE3	Connect CPU directly	RS232	Diagram 1	XINJE XD/XE series
			RS485	Diagram 2	

2.45.2 Parameters

1. HMI setting

Parameters	Recommended setting	Other settings for choice	Notes
PLC type	XINJE XD/XE series	XINJE XD/XE series /Modbus RTU (panel is Master) /Modbus ASCII (panel is Master)	
Serial port	RS232	RS232/RS485	
Data bit	8		
Stop bit	1		
Parity	Even parity		
Baud rate	19200	4800/9600/19200/38400/115200	
Station no.	1	0~255	

XINJE XD/XE series default parameters:

The screenshot shows a 'Communicate parameters' dialog box with the following settings:

- Baud Rate:** Radio buttons for 4800, 56000, 9600, 57600, 19200 (selected), 115200, 38400, 187500.
- Data bit:** Radio buttons for 7位, 8位 (selected).
- Stop bit:** Radio buttons for 1位 (selected), 2位.
- Checksum:** Radio buttons for No parity, Odd, Even (selected).
- Delay:** Send delay time: 0 ms.
- Send data:** Send data, Virtual Station.
- Word exchange:** Word exchange, Retry Tim 3.

2. PLC setting

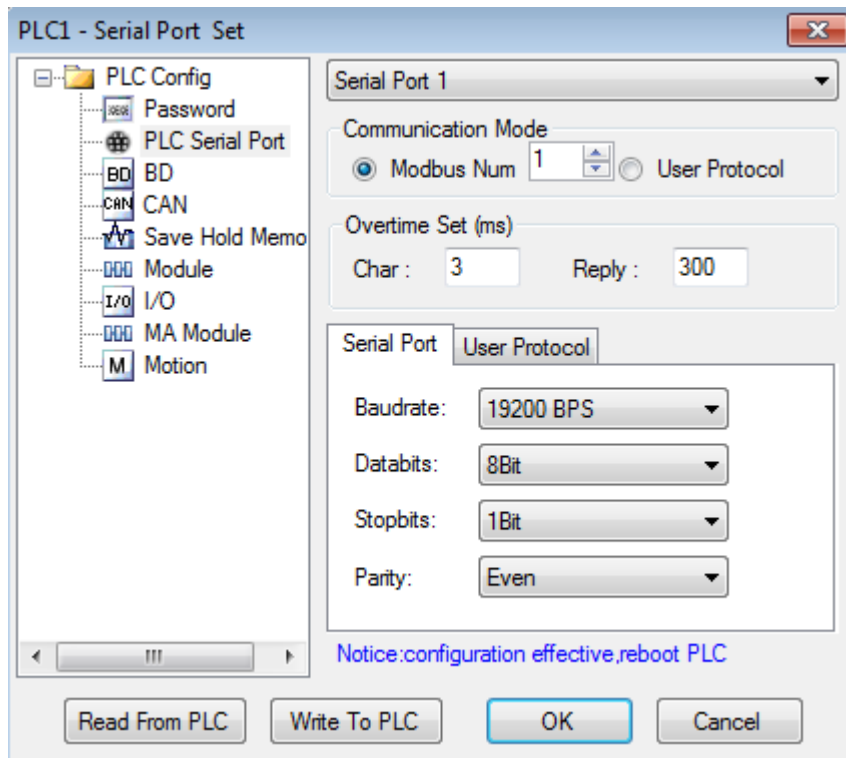

2.45.3 Cable making

1. XD/XE series PLC CPU (RS232 port)

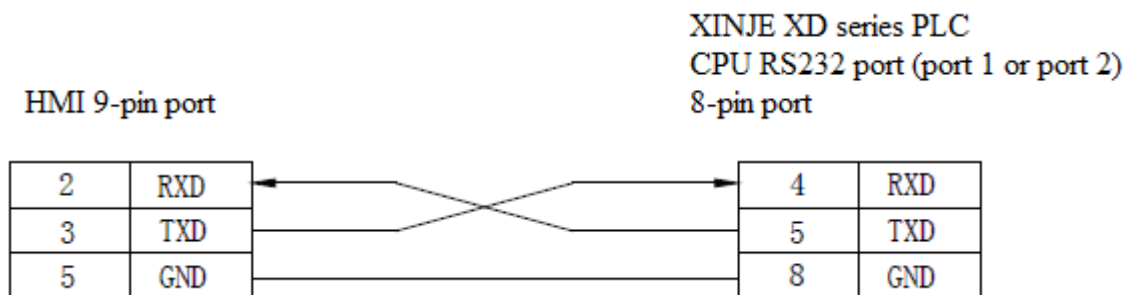

Diagram 1

2. XD/XE series PLC CPU (RS485 port)



Diagram 2

2.45.4 Device address

PLC address type	Range	Object type	Explanation
X	0~77	Bit	Input relay
X1 xxxx	0~1777	Bit	Extended module input relay
X2 xxxx	0~477	Bit	Extended BD input relay
Y	0~77	Bit	Output relay
Y1 xxxx	0~1777	Bit	Extended module output relay
Y2 xxxx	0~477	Bit	Extended BD output relay
M	0~7999	Bit	Internal relay
S	0~1023	Bit	Flow
SM	0~2047	Bit	Internal relay, special using
T	0~575	Bit	Timer
C	0~575	Bit	Counter
ET	0~31	Bit	Timer, precise timer
SE	0~31	Bit	Sequence block wait instruction special coil
HM	0~959	Bit	Internal relay, power-off retentive
HS	0~127	Bit	Flow, power-off retentive
HT	0~95	Bit	Auxiliary relay, power-off retentive
HC	0~95	Bit	Counter, power-off retentive
HSC	0~31	Bit	Counter, high speed counter
D	0~7999	Word/DWord	Data register
ID	0~99	Word/DWord	Analog input
ID1xxxx	0~1599	Word/DWord	Extended module analog input
ID2xxxx	0~499	Word/DWord	Extended BD analog input
QD	0~99	Word/DWord	Analog output
QD1xxxx	0~1599	Word/DWord	Extended module analog output
QD2xxxx	0~499	Word/DWord	Extended BD analog output
SD	0~2047	Word/DWord	Data register, special using
TD	0~575	Word/DWord	Timer value
CD	0~575	Word/DWord	Counter value
ETD	0~31	Word/DWord	Timer value, precise timer

HD	0~999	Word/DWord	Data register
HSD	0~499	Word/DWord	Data register, power-off retentive
HTD	0~95	Word/DWord	Timer value, power-off retentive
HCD	0~95	Word/DWord	Counter value, power-off retentive
HSCD	0~31	Word/DWord	Counter value, high speed counter
FD	0~6143	Word/DWord	FlashROM register
SFD	0~1999	Word/DWord	FlashROM register, special using
FS	0~47	Word/DWord	Special security register
DM	0~7984	Word	For data register
DX	0~60	Word	For data register
DX1xxxx	0~1760	Word	For data register, extended module
DX2xxxx	0~460	Word	For data register, extended BD
DY	0~60	Word	For data register
DY1xxxx	0~1760	Word	For data register, extended module
DY2xxxx	0~460	Word	For data register, extended BD
DS	0~1008	Word	For data register
DSM	0~2032	Word	For data register, special function using
DT	0~560	Word	For data register
DC	0~560	Word	For data register
DET	0~16	Word	For data register, precise timer
DSE	0~16	Word	For data register, WAIT instruction
DHM	0~944	Word	For data register, power-off retentive
DHS	0~112	Word	For data register, power-off retentive
DHT	0~80	Word	For data register, power-off retentive
DHC	0~80	Word	For data register, power-off retentive
DHSC	0~16	Word	For data register, high speed counter

2.46 LG XGB series PLC

2.46.1 Device type

Series name	CPU	Connection	Communication	Cable	Choose PLC type in Touchwin
XGB	XBC-DR10E	Programming port	RS232	Diagram 1	LG XGT/XGK series (CPU Direct)
	XBC-DR20E		RS232	Diagram 2	LG Master-K80/120 Series (CNet)
	XBC-DR30E	CNet port	RS485	Diagram 3	

2.46.2 Parameters

1. Programming port

(1) HMI setting

Parameter	Recommended setting	Settings for choice	Notes
PLC type	LG XGT/XGK series (CPU Direct)		
Port	RS232		
Data bit	8		
Stop bit	1		
Parity	No parity		
Baud rate	115200		
Station no.	0		

LG XGT/XGK series (CPU Direct) default parameters:

The screenshot shows a 'Communicate parameters' dialog box with the following settings:

- Baud Rate:** 4800, 9600, 19200, 38400, 56000, 57600, 115200 (selected), 187500
- Data bit:** 7位, 8位 (selected)
- Stop bit:** 1位 (selected), 2位
- Checksum:** No parity (selected), Odd, Even
- Delay:** Send delay time: 0 ms
- Send data:**
- Virtual Station:**
- Word exchange:**
- Retry Tim 3:** 3

Note: XGB series (CPU direct) only support baud rate 115200, cannot change the station no.

2. CNet port

(1) HMI setting

Parameter	Recommended setting	Settings for choice	Notes
PLC type	LG Master-K80/120 series (CNet)		
Port	RS232	RS232/RS485	
Data bit	8		
Stop bit	1		
Parity	No parity		
Baud rate	9600	9600/19200/38400/115200/187500	
Station no.	0	0~255	

LG Master-K80/120 series (CNet) default parameters:

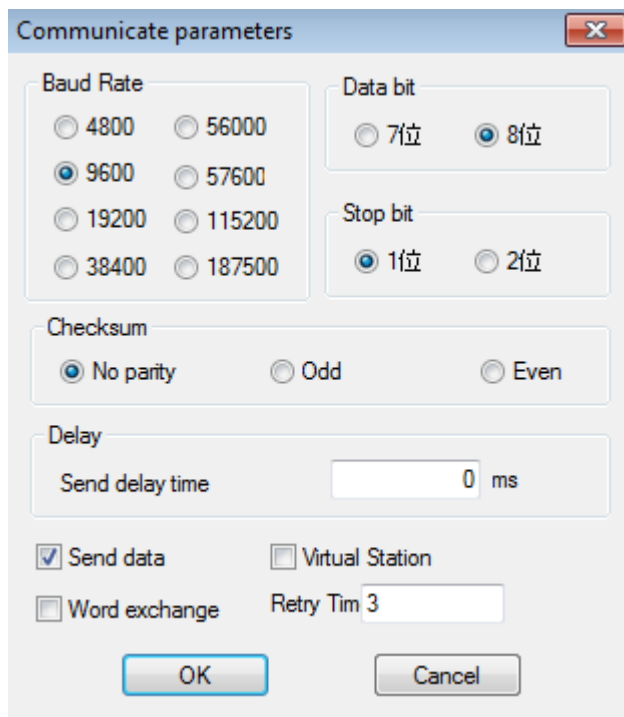

(2) PLC setting

a. RS232 communication

Tools-Network Manager to set parameters:

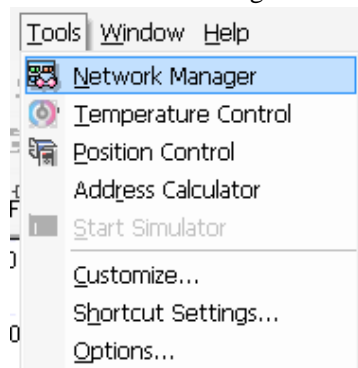

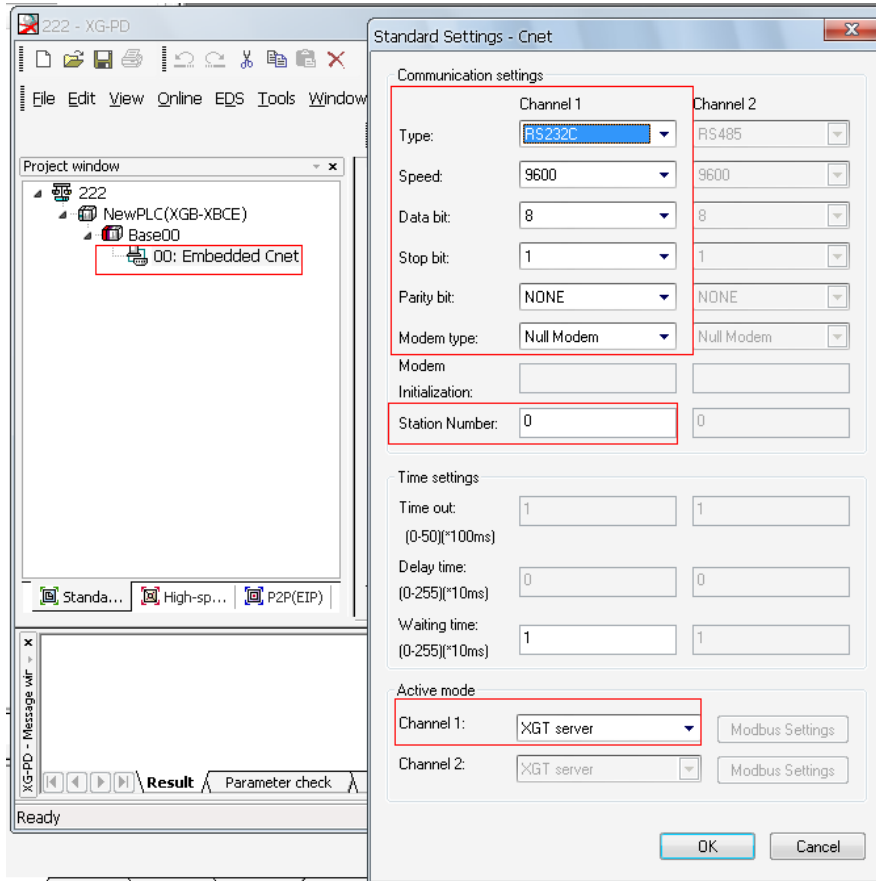

b. RS485 communication

Tools-Network Manager to set parameters:

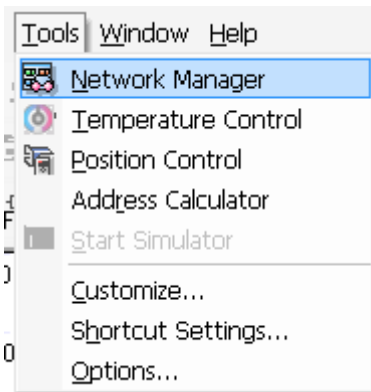

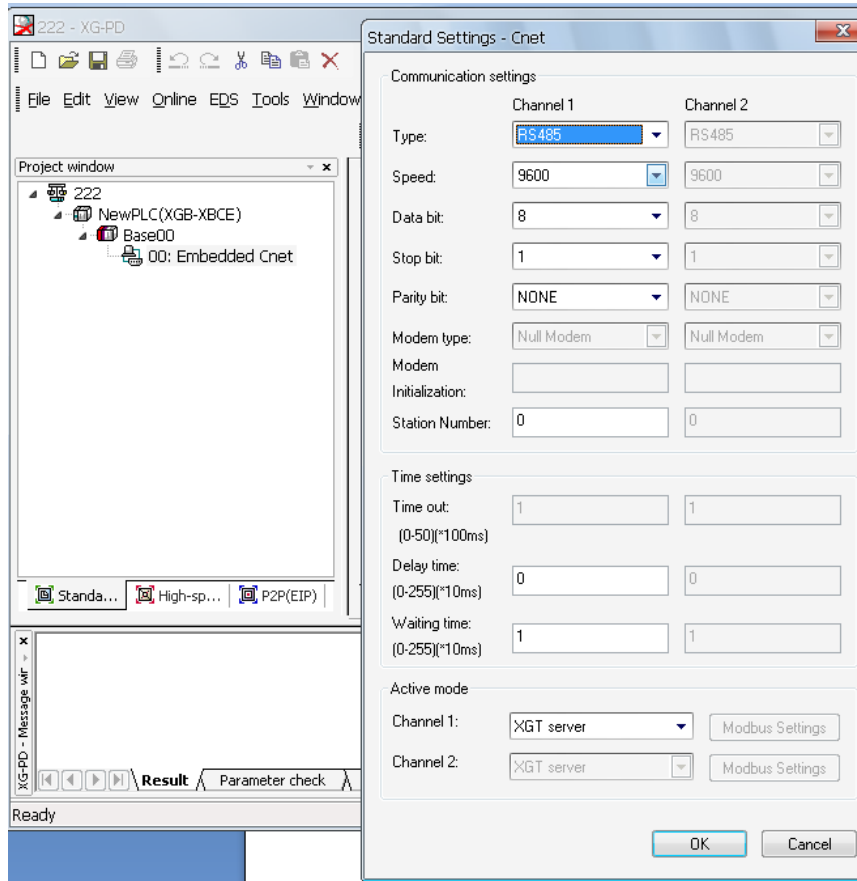

2.46.3 Cable making

1. Programming port RS232

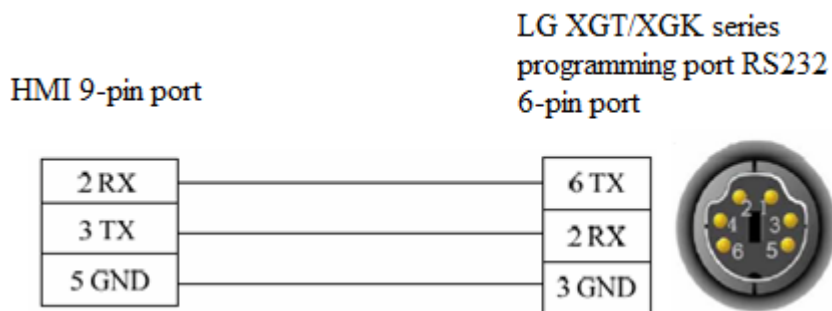

Diagram 1

2. CNet port RS232

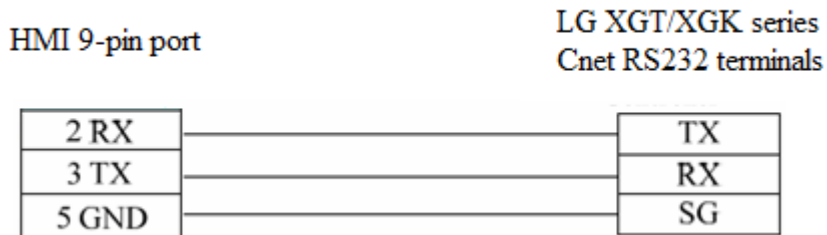

Diagram 2

3. CNet port RS485

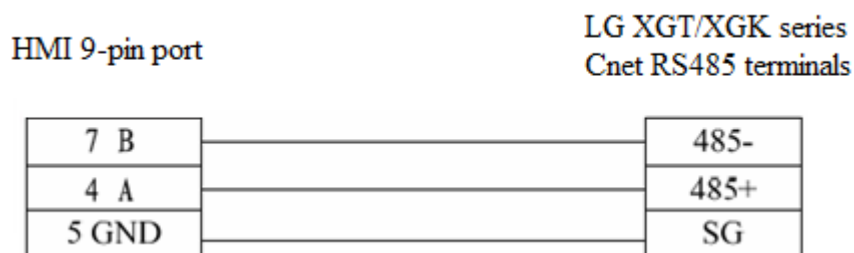

Diagram 3

2.46.4 Device address

PLC address	Range	Object type	Explanation
P	0.0~65535.F	Bit	External I/O
	65535	Word/DWord	Data register
M	0.0~65535.F	Bit	Internal auxiliary output
	65535	Word/DWord	Data register
L	0.0~65535.F	Bit	External output
	65535	Word/DWord	Data register
F	0.0~65535.F	Bit	Data register
	65535	Word/DWord	Data register
T	65535	Word/DWord	Data register
	65535	Bit	Timer
C	65535	Word/DWord	Data register
	65535	Bit	Counter
D	65535	Word/DWord	Data register
	0.0~65535.F	Bit	Relay
S	65535	Bit	Relay
K	65535	Word/DWord	Data register
	0.0~65535.F	Bit	Relay
Z	65535	Word/DWord	Data register

	0.0~65535.F	Bit	Relay
N	65535	Word/DWord	Data register
	0.0~65535.F	Bit	Relay
R	65535	Word/DWord	Data register
	0.0~65535.F	Bit	Relay
ZR	65535	Word/DWord	Data register
	0.0~65535.F	Bit	Relay
TS	65535	Word	Data register
CS	65535	DWord	Data register

2.47 Koyo Click series

2.47.1 Device type

Koyo Direct Logic series DL05, DL250... (connect to CPU unit directly)

Series	CPU	Connection module	Port type	Wiring diagram	The PLC type in TouchWin
Click		Connect to CPU RJ-11 port (RS232 port)	RS232	Diagram 1	Koyo Click series

2.47.2 Parameter setting

1. HMI setting

Parameter	Recommended setting	Optional settings	Notes
PLC type	Koyo Click series		
Port type	RS232	RS232/RS422	
Data bit	8		
Stop bit	1		
Parity	Odd parity		
Baud rate	38400	9600/19200/38400	
Station no.	1	1~247	

Koyo Click series default communication parameters:

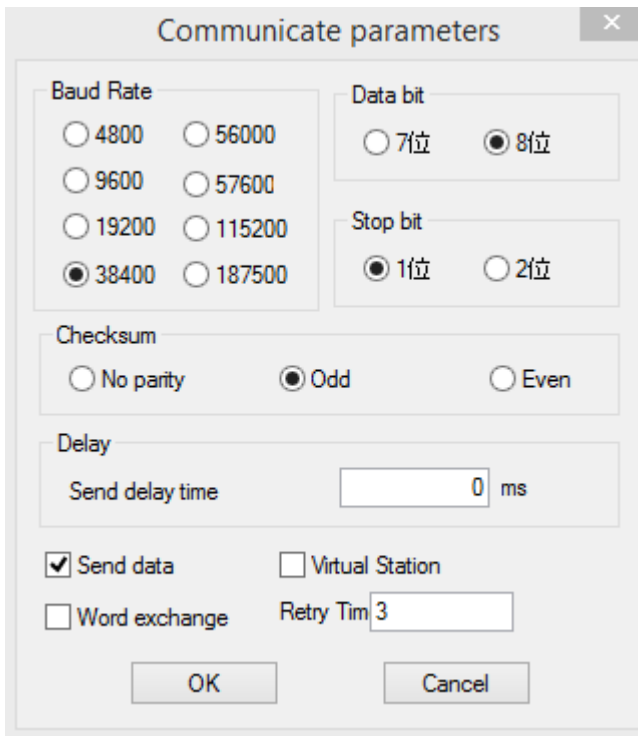

2. PLC setting

Please refer to Koyo S series PLC settings.

2.47.3 Cable making

RS232 wiring:

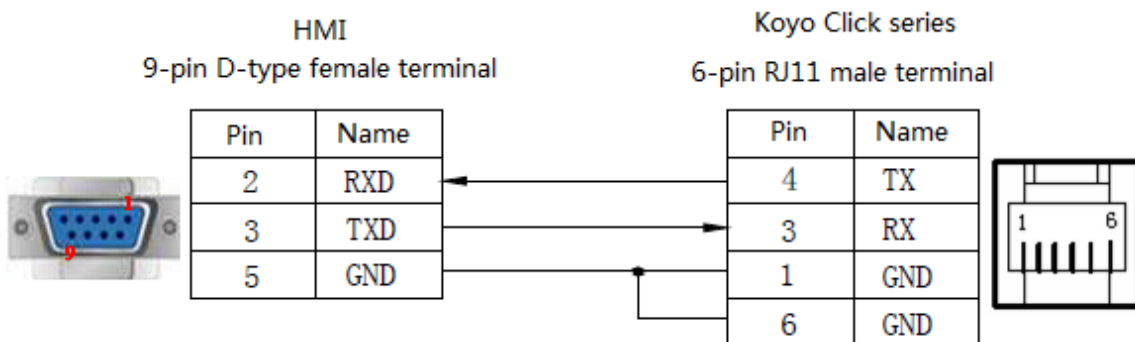

2.47.4 Device address

Device type	Range	Object type	Explanation
X0	1~16	Bit	Input
X1	1~16	Bit	I/O module 1 input

X2	1~16	Bit	I/O module 2 input
Y0	1~16	Bit	Output
Y1	1~16	Bit	I/O module 1 output
Y2	1~16	Bit	I/O module 2 output
C	1~2000	Bit	Control bit
T	1~500	Bit	Timer
CT	1~250	Bit	Counter
SC	1~1000	Bit	System control bit
DS	1~4500	Word	Data temporary storage register, support double words
DD	1~1000	Word/DWord	Data temporary storage register, support double words
TD	1~500	Word	Timer present value
CTD	1~250	Word/DWord	Counter present value, support double words
SD	1~1000	Word	System data temporary storage register
DH	1~500	Word/DWord	Data temporary storage register
DF	1~500	DWord	Data temporary storage register (double words)
XD	0	Word/DWord	Input state temporary storage register
YD	0	Word/DWord	Input state temporary storage register
TXT	1~1000	Word/DWord	texts temporary storage register

2.48 Mitsubishi Melsec protocol

2.48.1 Device type

Series	Communication type	Cable diagram	PLC model in Touchwin software
Mitsubishi L series Mitsubishi Q series	RJ45	Diagram 1 or 2	Mitsubishi Melsec

2.48.2 Parameter settings

Take Mitsubishi L series PLC as an example to explain the Melsec protocol device parameter settings.

1. PLC software settings

Select project area-PLC parameter-Ethernet terminal setting, set the PLC IP address. The communication data code please set to binary code communication. Select “permit write (FTP & MC protocol) when running.



click “open the setting”, select “TCP” protocol and “MC” open mode, and set the station port no. (range is 0401H~1387H, 1392H~FFFEH).



2. HMI setting

Please select the HMI type, click next.

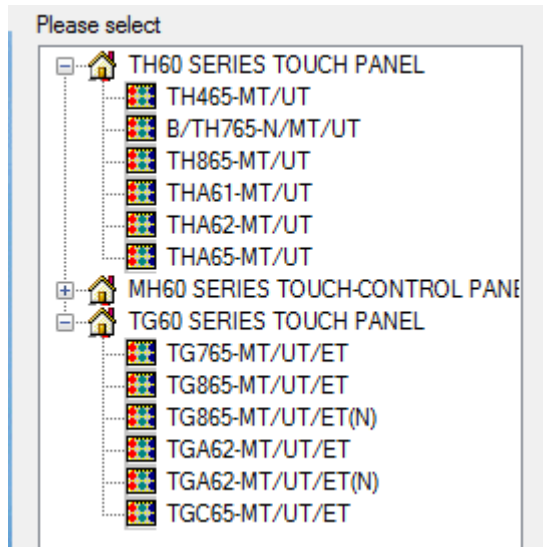

Select Net device. The IP address in own devices is HMI IP address.

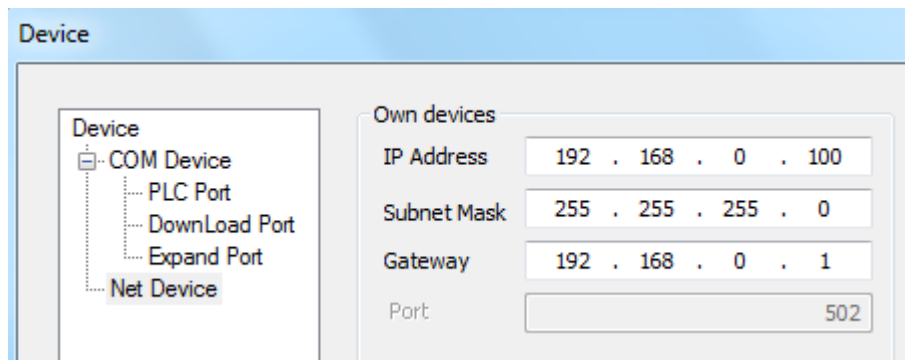

Right click Net device, click New. Then input the project name.

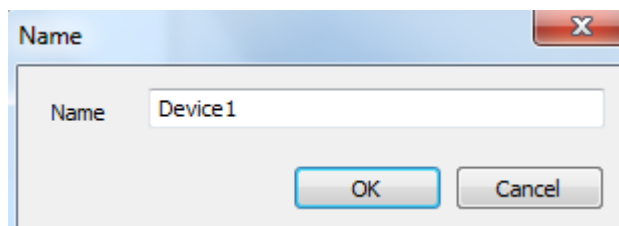
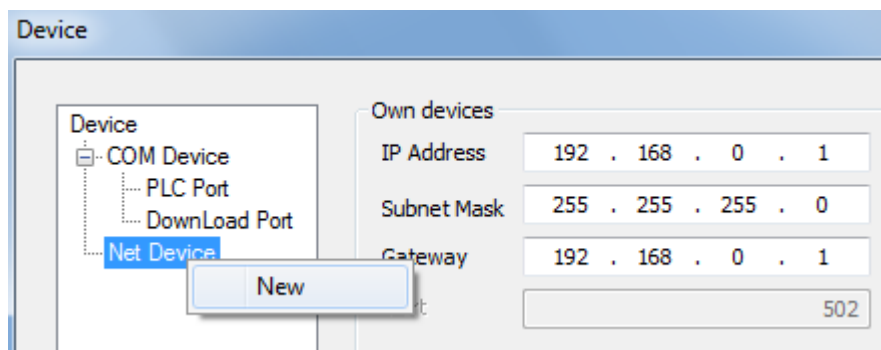

Select Mitsubishi Melsec series in the device list. The IP address is Mitsubishi PLC IP address, the port 1025 is the station port no. setting in the Mitsubishi PLC.

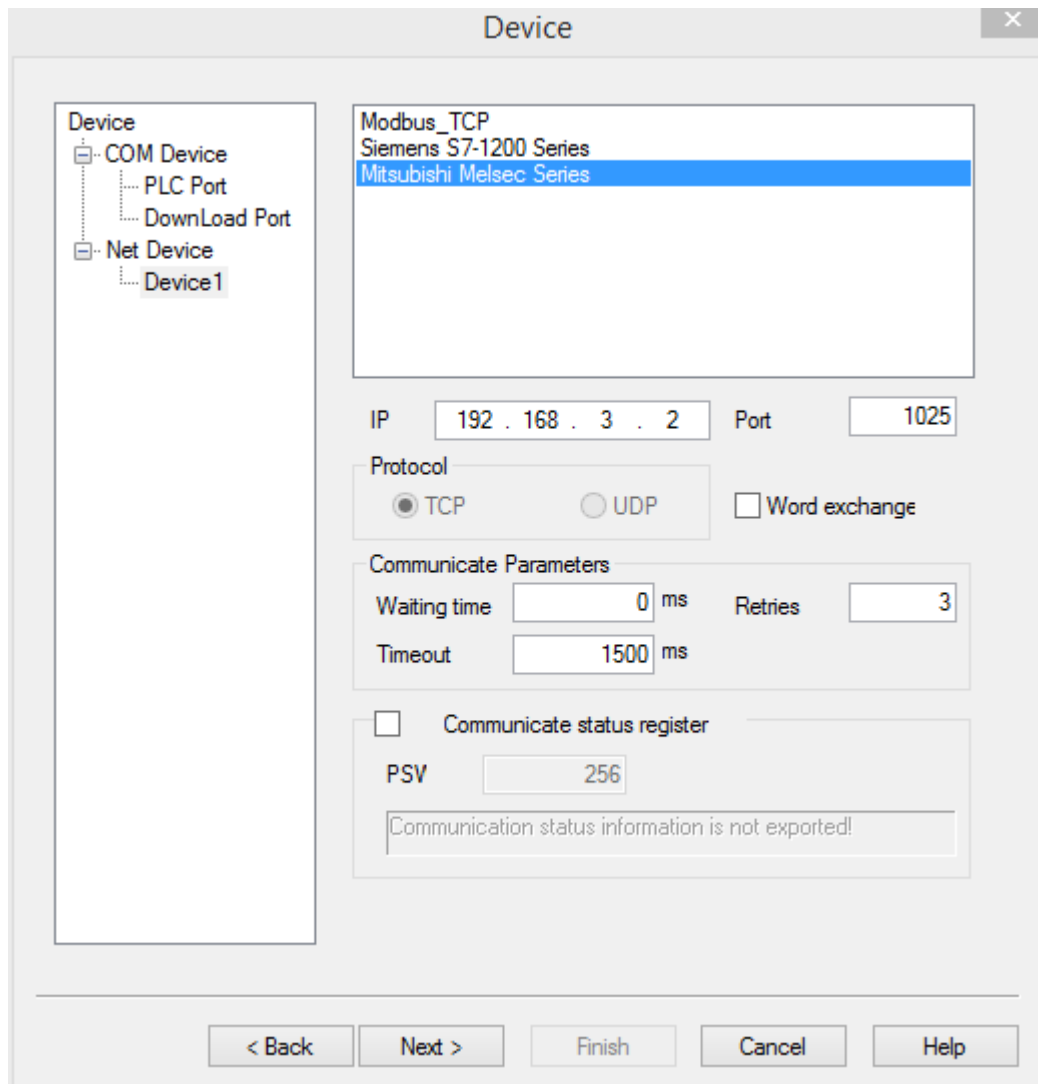

Communication parameters: please use the default parameters. Communication status register: if select this item, the status will occupy 4 registers. The register address can be set by user. If set the address to PSW256, the register meanings are shown as the following.

PSW256: communication succeeded times

PSW257: communication failed times

PSW258: timeout times

PSW259: communication error times.

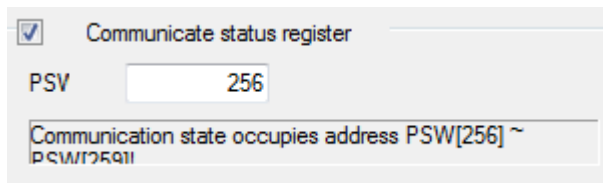

Then click next to finish the project setup.

In the editing screen, when user defines the button object, please select device 1.

Button

Object Operate Button Color Position

Station

Device Device 1

VirStaNO 0 Station 0

Object

ObjType 0 0

indirect indirect

2.48.3 Cable making

RJ45 straight through cable (connect HUB) or RJ45 crossover cable:

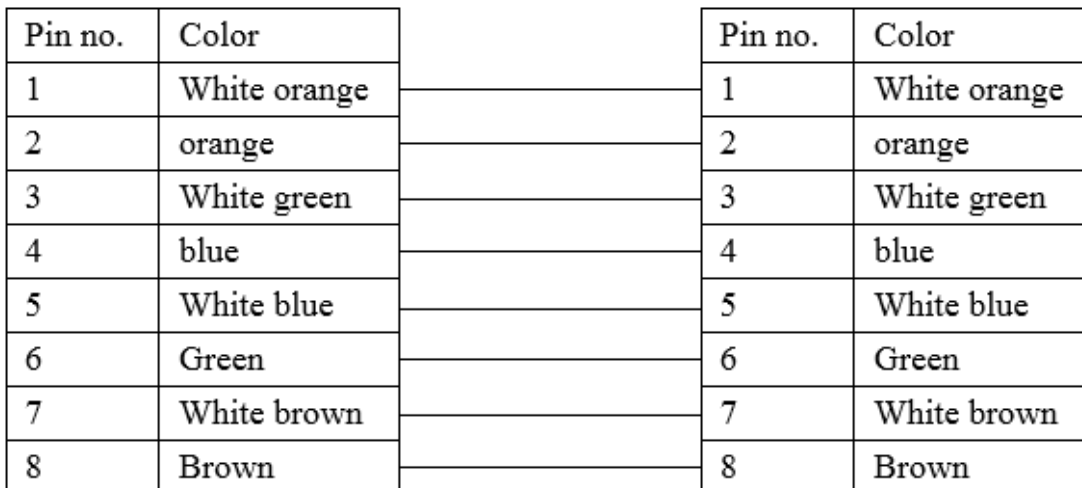

Diagram 1

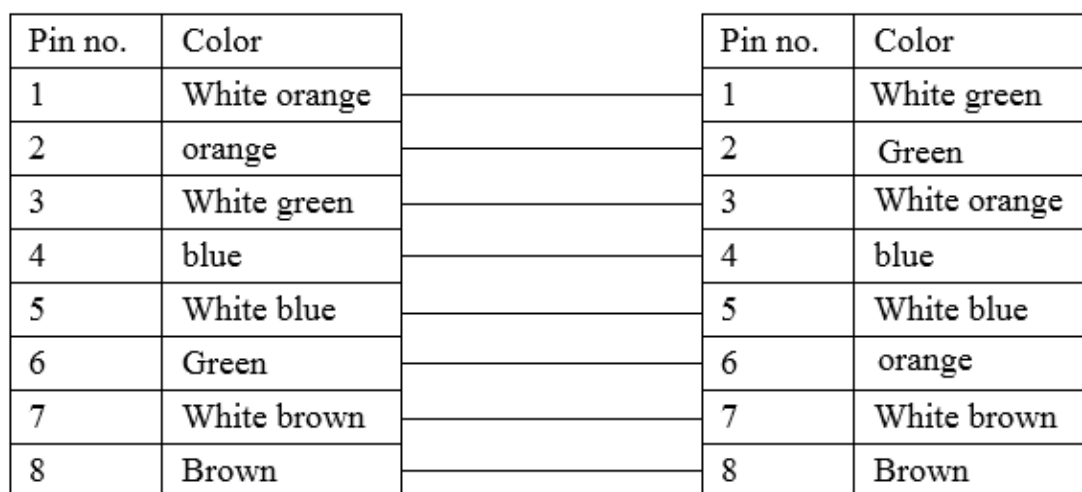

Diagram 2

2.48.4 Device address

PLC address	Range	Object type	Explanation
X	0~1fff	Bit	Input
Y	0~1fff	Bit	Output
M	0~8191	Bit	Internal auxiliary relay
L	0~8191	Bit	Lock relay
F	0~2047	Bit	Alarm relay
V	0~2047	Bit	Variable address relay
B	0~1fff	Bit	Link relay
TS	0~2047	Bit	Timer relay
SS	0~2047	Bit	Holding delay timer relay
CS	0~1023	Bit	Counter relay
SB	0~7ff	Bit	Special link relay
S	0~2047	Bit	Stepper relay
SM	0~2047	Bit	Special relay
D	0~65535	Word/DWord	Data register
W	0~1fff	Word/DWord	Link register
TC	0~2047	Word/DWord	Timer coil
TN	0~2047	Word/DWord	Timer present value
SC	0~2047	Word/DWord	Holding delay timer coil
SN	0~2047	Word/DWord	Holding delay timer present value
CC	0~1023	Word/DWord	Counter coil
CN	0~1023	Word/DWord	Counter coil
SW	0~7ff	Word/DWord	Special link register
SD	0~2047	Word/DWord	Special register
Z	0~19	Word/DWord	Variable address register

2.49 Free type (panel is slave)

2.49.1 Device type

Series	Port type	Cable making	The PLC model in the Touchwin software
The device with serial port and support free type protocol	RS485	diagram 1	Free type (panel is slave)
	RS232	diagram 2	
	RS422	diagram 3	

2.49.2 Parameter setting

1. HMI setting

Parameter	Recommended setting	Optional setting	Notes
PLC model	Free type (panel is slave)		
Port type	RS485	RS485/RS232/RS422	
Data bit	8	7/8	
Stop bit	1	1/2	
Parity	Even parity	Even /odd /no	
Baud rate	9600	4800/38400/9600/115200/19200/187500	
Station no.	1	0~255	

Free type (panel is slave) default parameters:

The screenshot shows a 'Communicate parameters' dialog box with the following settings:

- Baud Rate:** 9600 (selected), 4800, 56000, 57600, 19200, 115200, 38400, 187500.
- Data bit:** 8位 (selected), 7位.
- Stop bit:** 1位 (selected), 2位.
- Checksum:** Even (selected), No parity, Odd.
- Delay:** Send delay time: 0 ms.
- Send data:** checked.
- Virtual Station:** unchecked.
- Word exchange:** unchecked.
- Retry Tim:** 3.

2. Free type protocol

The HMI free type protocol is a simple protocol for connecting HMI with controller. The controller is the master station, the HMI is slave station. It only needs to write simple communication program in the controller but no need to make communication interruption service program.

The controller sends a request to the HMI, the HMI will reply after receiving the request. The max data exchanging between controller and HMI is 256 words, the HMI address range is PSW256~PSW511. Each bit of the word can be used to coil. For example, coil PSWx.i (x=256~511, i=00~15).

(1) Request format:

Station no.	Command	Address	Length	Data	Parity
-------------	---------	---------	--------	------	--------

Station no.: HMI station no. (0~255, 0 is broadcast mode, the HMI no need to reply)

Command: “R” is HMI read, “W” is HMI write

Address: index no., the index no. corresponding to HMI PSW256~PSW511 is 0~256

Length: PSW numbers (1~256) needs to read and write

Data: PSW value, there is no data for command “R”

Parity: add all the bytes from station no. to data (not include parity), get the remainder of 0x100 (if the parity is 0x5A, ignore it, not check)

(2) Data response format:

Station no.	State	Address	Length	Data	Parity
-------------	-------	---------	--------	------	--------

State: communication state

0--- normal

1--- address error

2--- length error

3--- range error (address+length > 256)

4--- command error

When the command is “W” or abnormal, there is no address, length and data

Data format:

PSWi (high)	PSWi (low)	PSWi+1 (high)	PSWi+1 (low)	PSWi+n-1 (high)	PSWi+n-1 (low)
----------------	---------------	------------------	-----------------	-------	--------------------	-------------------

Address is I, length is n.

(3) Protocol

The controller sends a request to the HMI, the HMI will check the parity after receiving the request. If the parity is correct, and the station no. is equal to the HMI, the HMI will reply the request. Otherwise, the HMI will not reply.

The controller will check the overtime of HMI response. If the time is over 50ms, the controller will resend the request.

The HMI will check the overtime of receiving data. If the time is over 25ms, the HMI will initialize the communication and wait for the new request.

Read (read HMI data)

Controller

Station no.	“R”	Address	Length	Data	Parity
-------------	-----	---------	--------	------	--------

HMI

Station no.	State	Address	Length	Data	Parity
-------------	-------	---------	--------	------	--------

Data: PSW value

Write(write data in HMI)

Controller

Station no.	“W”	Address	Length	Data	Parity
-------------	-----	---------	--------	------	--------

HMI

Station no.	State	Parity
-------------	-------	--------

State: 0--- OK

(4) Application

- a. The controller read HMI data PSW256=0, PSW257=12
 Controller send: 01H 52H 00H 02H 55H
 HMI reply: 01H 00H 00H 02H 00H 00H 00H 0CH 0FH
- b. Controller write 256 in HMI PSW256
 Controller send: 01H 57H 00H 01H 01H 00H 5AH
 HMI reply: 01H 00H 01H

2.49.3 Cable making

1. RS485 cable

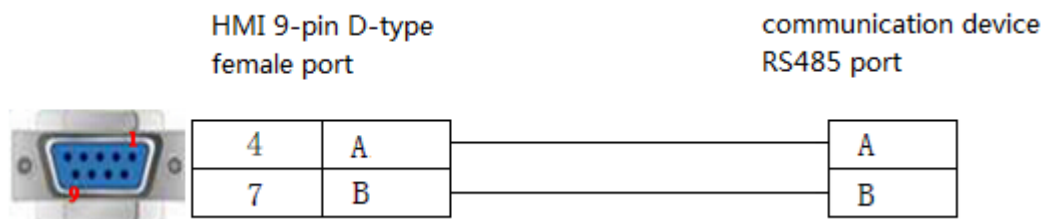

Diagram 1

2. RS232 cable

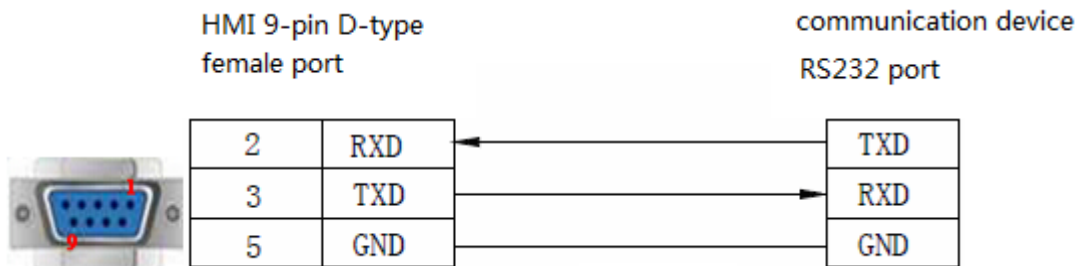
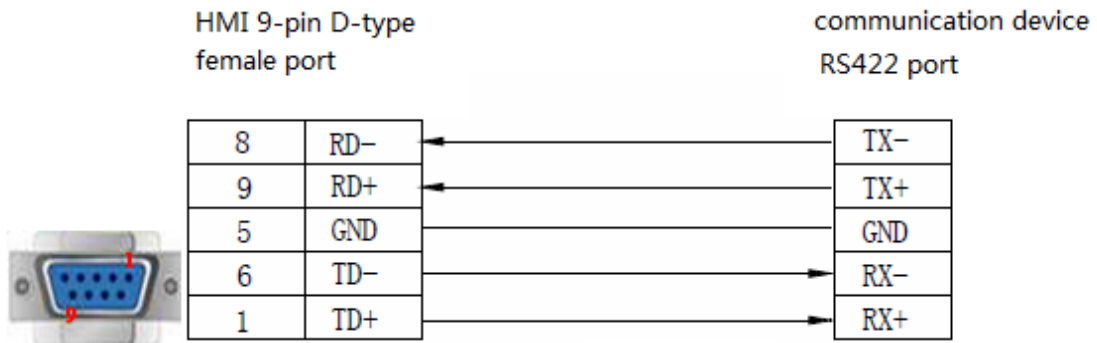

Diagram 2

3. RS422 cable



2.49.4 Device address

Address type	Range	Object type	Property	Notes
PSW	256.00~511.15	Bit	R/W	Internal coil
PSW	256~511	Word/Dword	R/W	Data register

2.50 Modbus-TCP device

2.50.1 Device type

Series name	Port type	Cable making	PLC model in Touchwin software
Ethernet device supporting Modbus TCP protocol	RJ45	Diagram 1, diagram 2	Modbus_TCP

2.50.2 Parameter setting

Take Xinje T-BOX as an example to explain the Modbus TCP parameter setting.

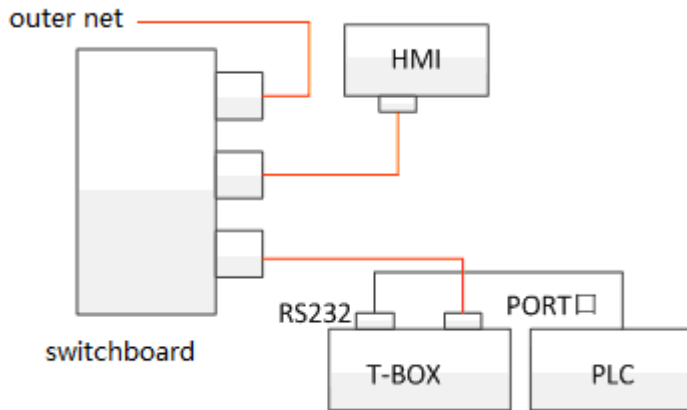

1. Hardware configuration

Wiring as the above diagram. Turn off of the TBOX DIP switch S3, make sure T-BOX is connected to the Ethernet. Power on the device. Make sure the PLC is connected to the Ethernet.

Version requirements:

T-BOX hardware version 2.10 please use PLC software XCPpro version 3.3

T-BOX hardware version 2.0 please use PLC software XCPpro version 3.0f.

Please turn off DIP switch S3 to make the Ethernet indentifying the T-BOX for the first time using. Please use fixed IP address (192.168.0.111) for the T-BOX and connect it in the Ethernet to configure the parameters. The IP of PC must be in the same gateway of T-BOX (192.168.0.***). As each T-BOX default IP is the same, only one T-BOX can be configured in the network at one time. Otherwise, the IP will be conflict.

2. T-BOX configuration

- (1) T-BOX Link LED always ON means it has connected to the Ethernet (no need connect to PC via RS232) when it connected to the Ethernet cable. Please use PLC software XCPpro to configure the T-BOX. Please turn off DIP switch S3 to make the Ethernet indentifying the T-BOX for the first time using. T-BOX is slave station, please turn on DIP switch S1.
- (2) Open XCPpro software, click option/Ethernet module settings. Click “refresh list”, it will show the T-BOX in the network. Double click the T-BOX to configure.

	Name	IP	Mask	DNS	Port	Comment
▶ 1	TBOX Defaulted	192.168.0.100	255.255.255.0	192.168.0.1	502	Defaulted TBOX,...	

The following is T-BOX setting window.

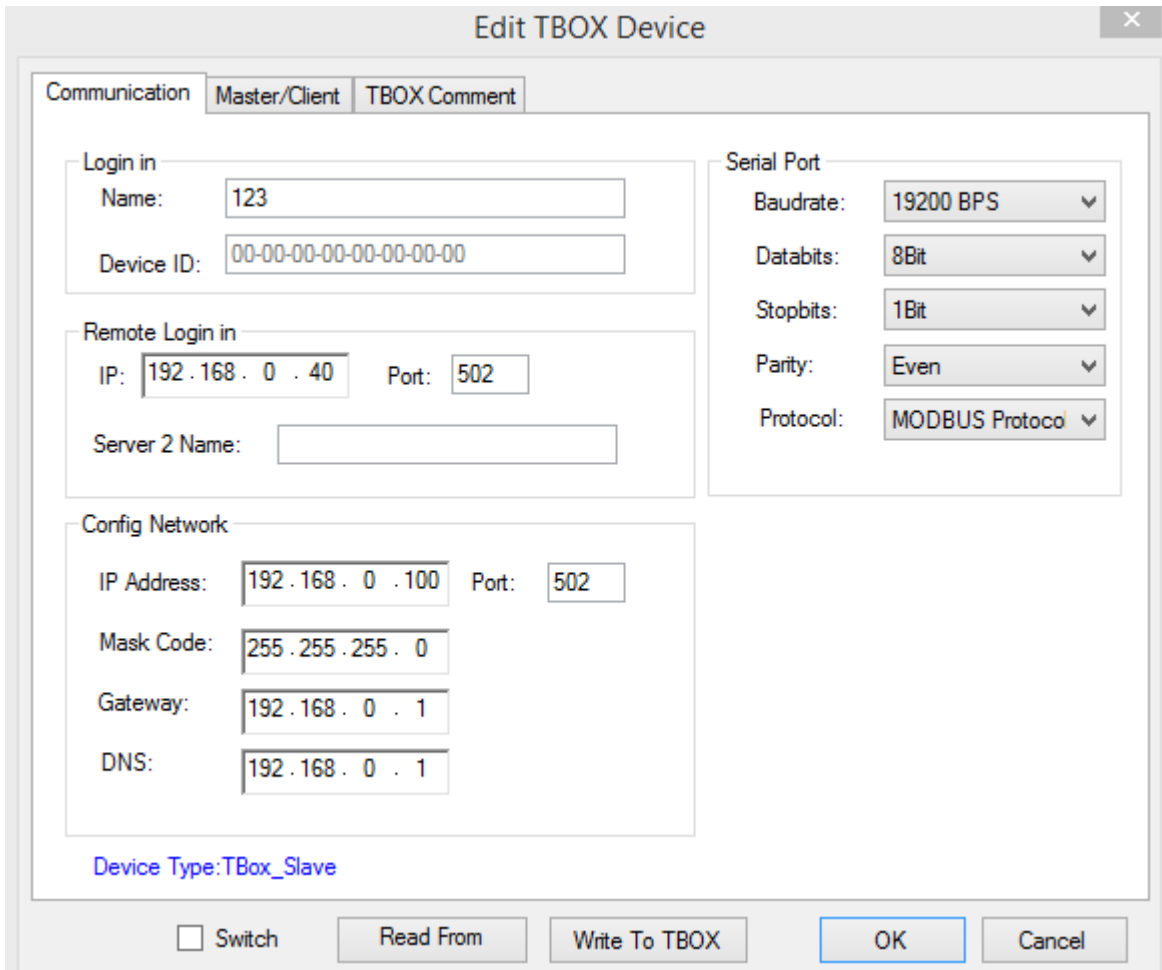

Log in name: set by user

Device ID: set by factory, cannot be changed

Remote log in: the purpose is to connect the TBOX with the Ethernet. If using Xinje server, the parameters no need to change. If user can build server, please set the IP, port and server name of the server.

Config network: the DIP switch S3 is OFF, please set the T-BOX IP, then turn ON S3. The network will indentify the fixed IP of T-BOX.

Serial port: the parameters can be changed, but the parameters must be same to the device connecting to the T-BOX.

Note: when it uses LAN, the remote log in address is:



- (3) When the S2 switch is OFF, shut down the log in server, click option/comm mode setting, set as the following to monitor the PLC.

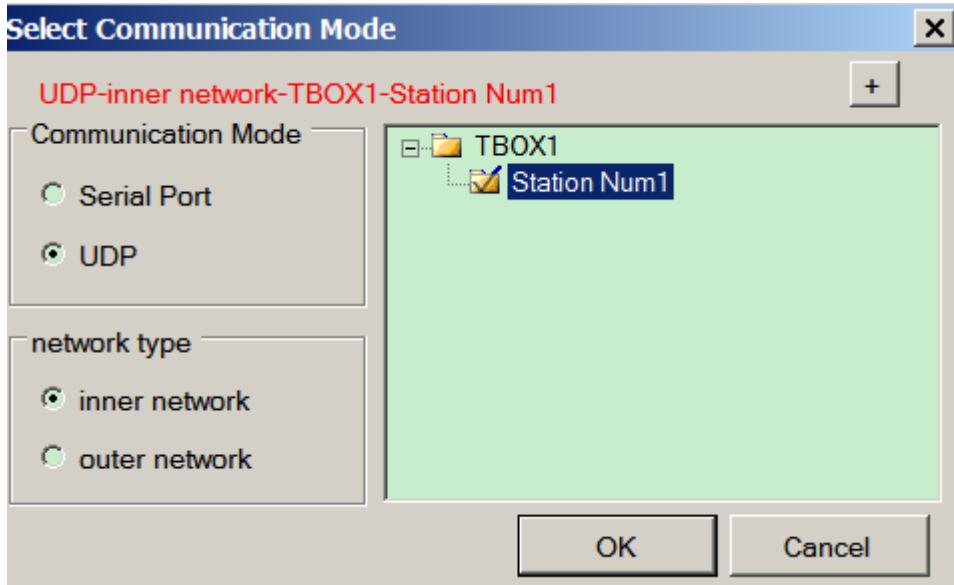

When using Xinje company server, the remote log in address is:

Remote Login in

IP: Port:

Server 2 Name:

Turn on S2 switch, startup the log in server, click option/comm mode setting, set as the following, it can monitor the PLC after logging in server successfully.

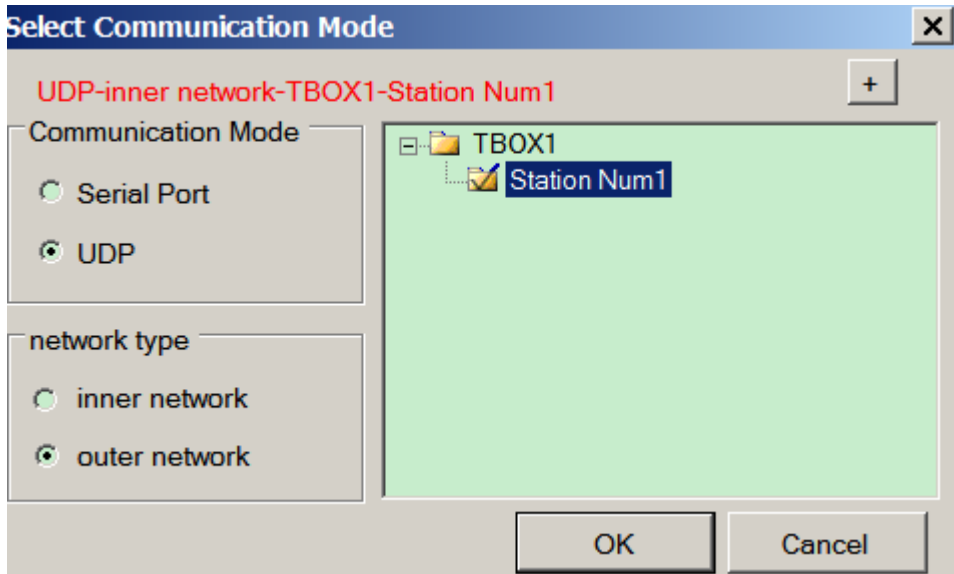

- (4) For the first time using, in order to make the network identify the T-BOX, the S3 switch is OFF. It can change the IP address after connecting successfully.

Config Network

IP Address: Port:

Mask Code:

Gateway:

DNS:

3. HMI software setting

- (1) Select the HMI model TN(-ET), TG(-ET), TE(-ET), click next, select “Net device” in the list. Please set the HMI IP address in the own devices. The IP cannot be conflict with other device.

- (2) Right click the “Net device”, select “New”. The new project name is device.

- (3) Please select Modbus TCP device for communicating with T-BOX. This IP is T-BOX IP address, the port 502 cannot be changed.

IP Port

- (4) The communication parameters please keep defaulted. If selecting communicate status register, the PSW256~PSW259 represents communicate successful times, communication

failure times, communication overtime times, communication error times. User can change the PSW address.

- (5) Click next to finish the setting. Then enter the editing screen, put a data input button on the screen, select “device”, the object type includes 4x(read and write, word object), 3x(read only, word object), 0x(bit object, read and write), 1x(read only, bit object).

- (6) Download the program in the HMI.

Note: T-BOX can connect multi-PLC through RS485, the station no. can be set in the XCPpro software. Please set the “send delay” time to improve the communication speed.

Station Num	IP

Station
1
2

Station Num
1
2

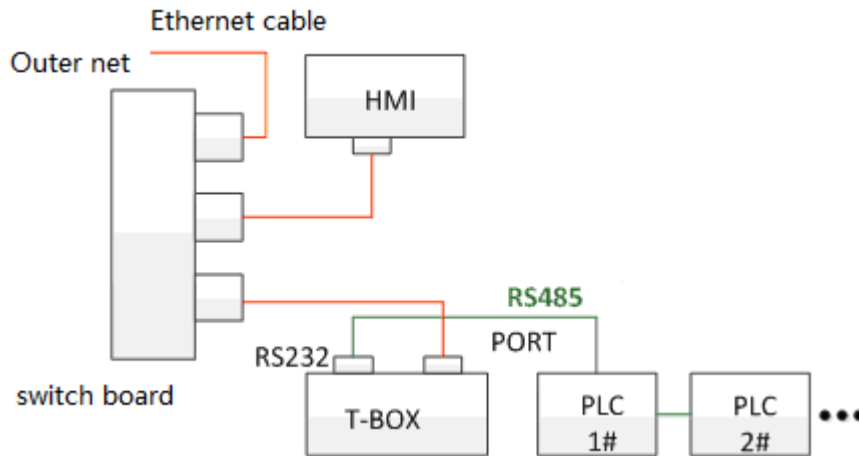

2.50.3 Cable making

RJ45 straight through cable (connect HUB) or RJ45 crossover cable:

Pin no.	Color		Pin no.	Color
1	White orange	—————	1	White orange
2	orange	—————	2	orange
3	White green	—————	3	White green
4	blue	—————	4	blue
5	White blue	—————	5	White blue
6	Green	—————	6	Green
7	White brown	—————	7	White brown
8	Brown	—————	8	Brown

Diagram 1

Pin no.	Color		Pin no.	Color
1	White orange	—————	1	White green
2	orange	—————	2	Green
3	White green	—————	3	White orange
4	blue	—————	4	blue
5	White blue	—————	5	White blue
6	Green	—————	6	orange
7	White brown	—————	7	White brown
8	Brown	—————	8	Brown

Diagram 2

2.50.4 Device address

Address	Range	Object type	property	Notes
0x	0~65535	Bit	R/W	I/O internal coil
1x	0~65535	Bit	R	I/O internal coil
4x	0.00~65535.15	Bit	R/W	I/O internal coil
4x	0~65535	Word/Dword	R/W	Data register
3x	0~65535	Word/Dword	R	Data register



WUXI XINJE ELECTRIC CO., LTD.

4th Floor, Building 7th, No.100 Dicuti Rd, Wuxi, China

Tel: 86-0510-85134139

Fax: 86-0510-85111290

www.xinje.com

Email: cheerfiona@gmail.com